

Model 1

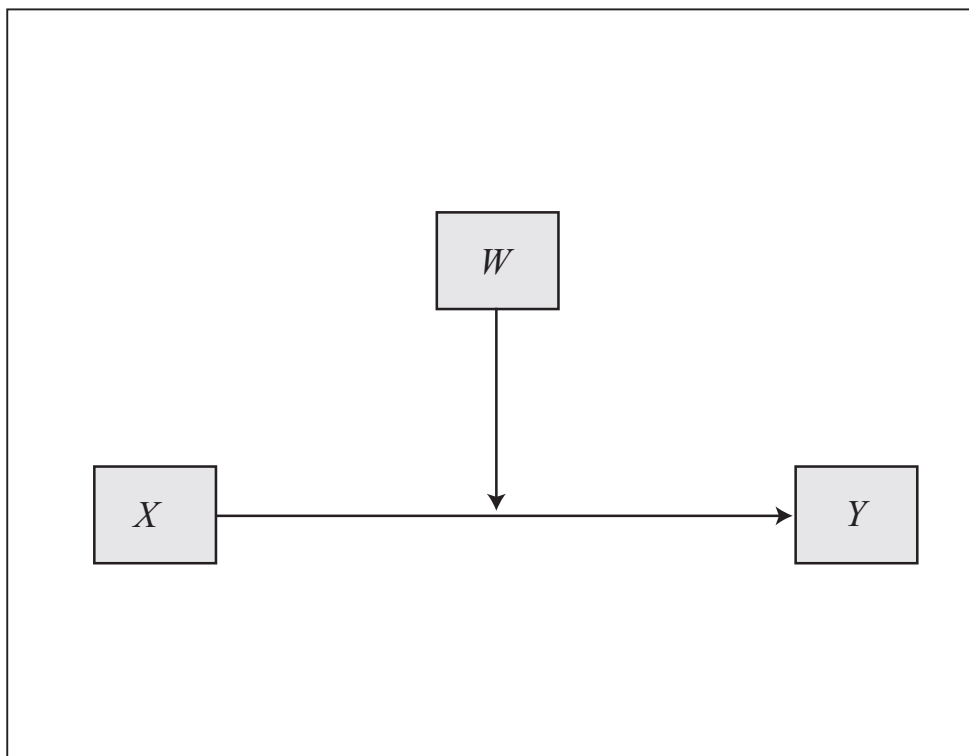

Model 2

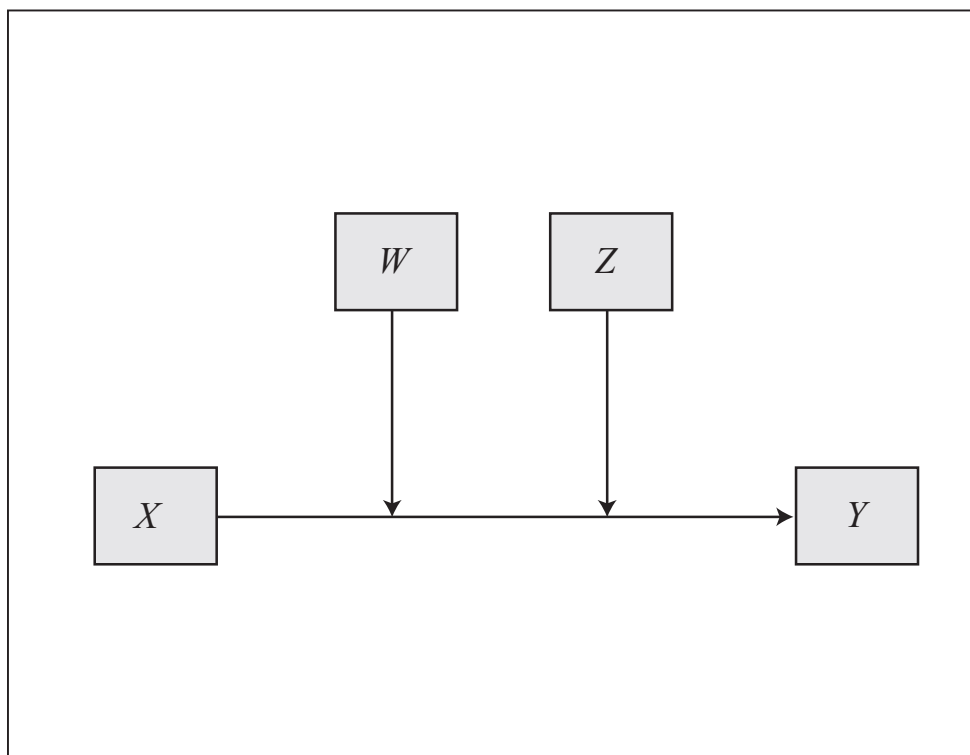
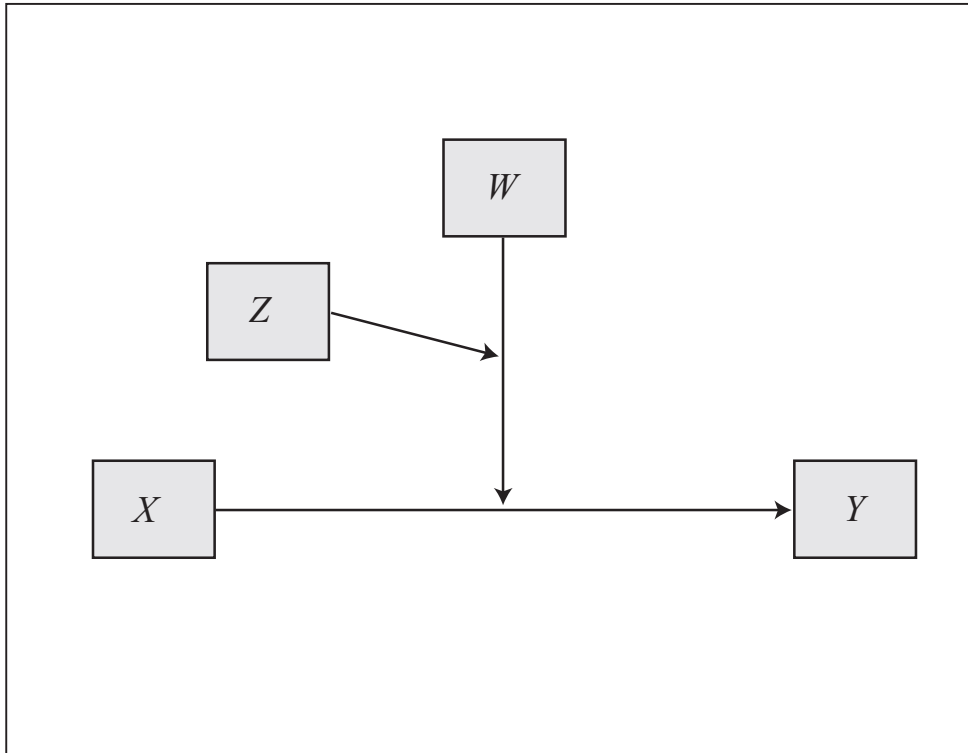
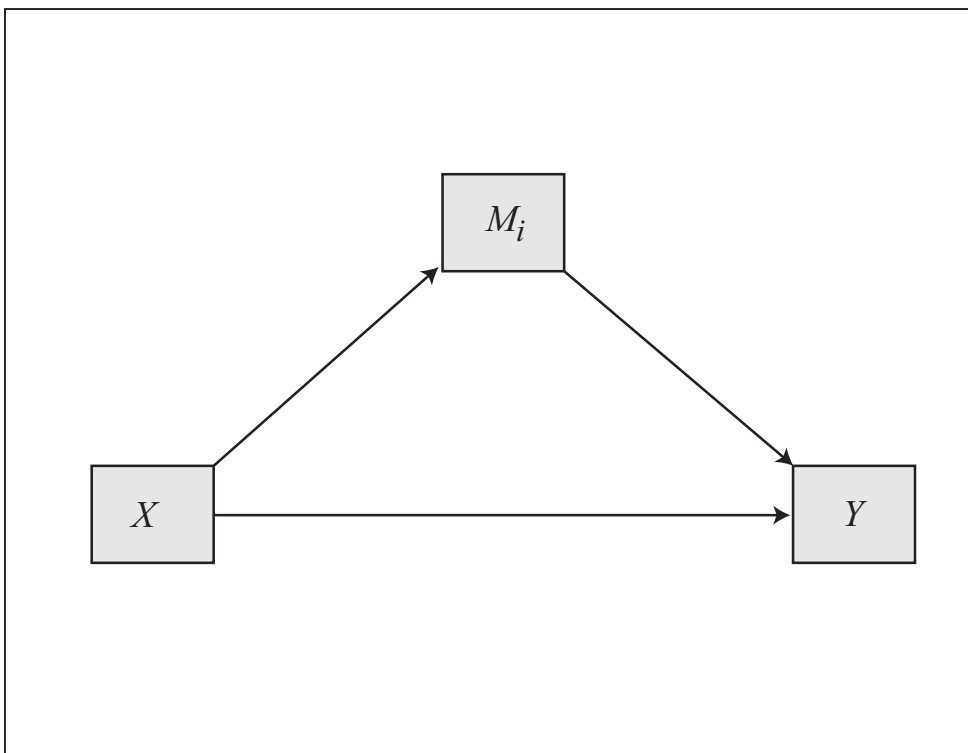

Model 3**Model 4**

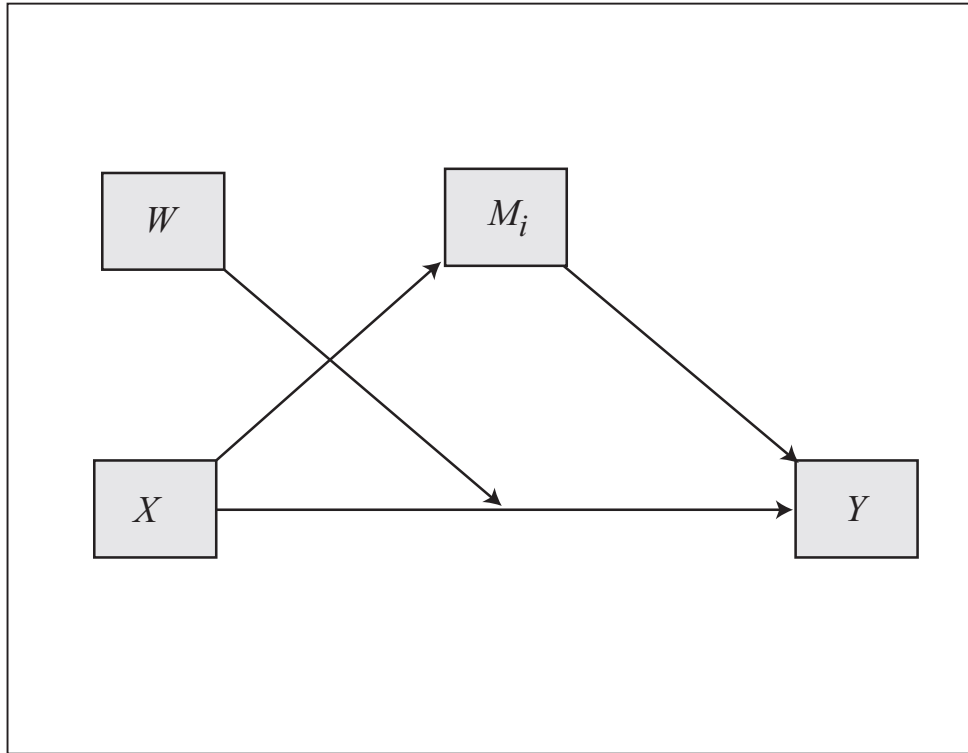
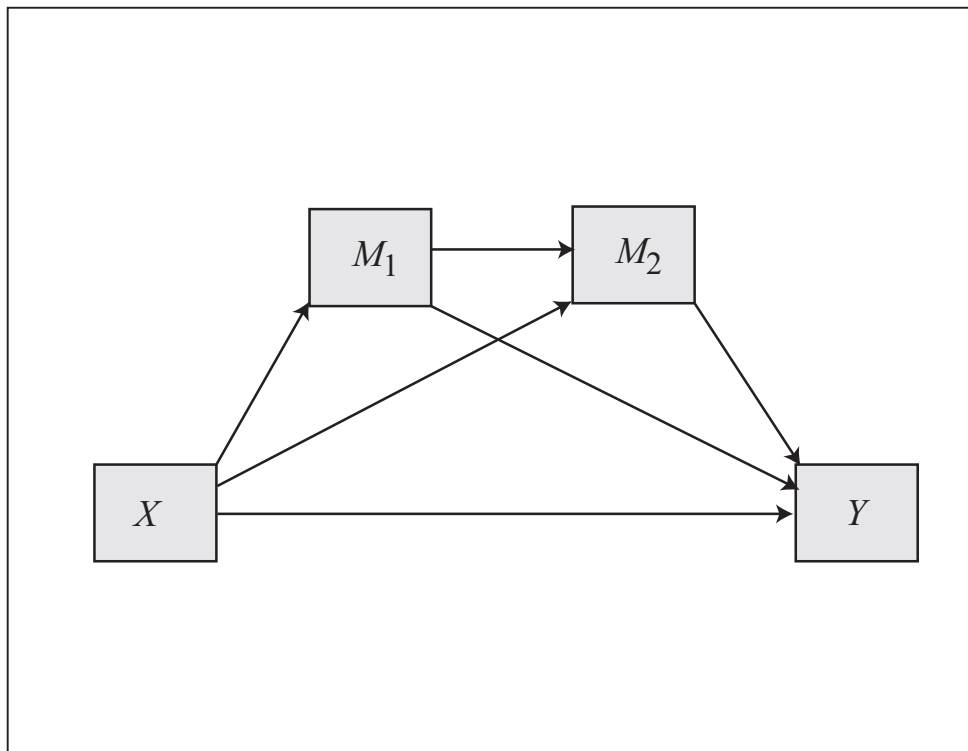
Model 5**Model 6**
(2 mediators)

Model 6
(3 mediators)

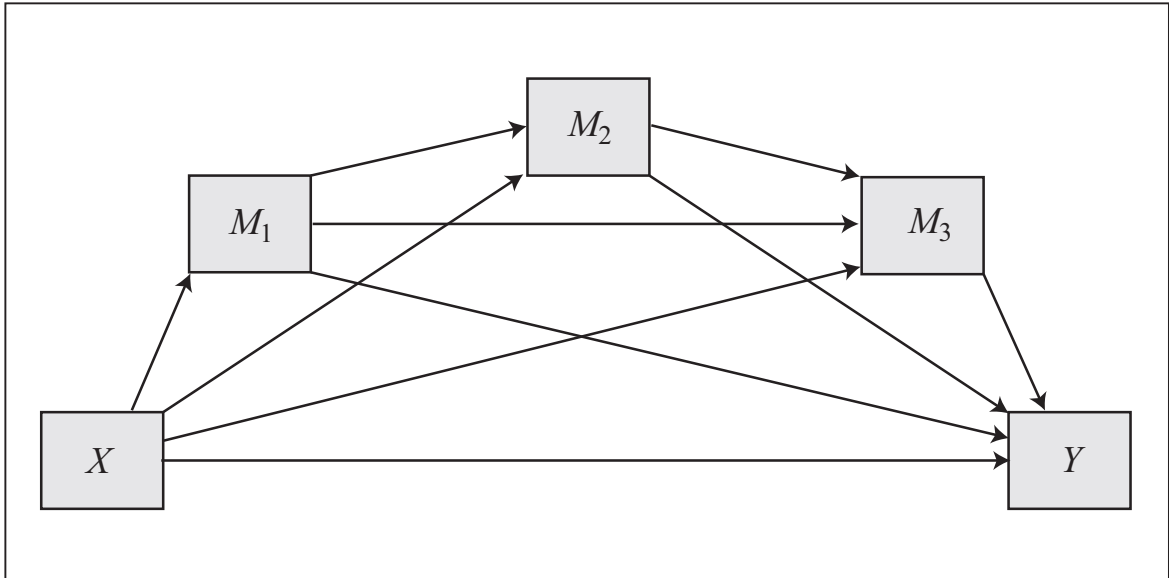

Model 6
(4 mediators)

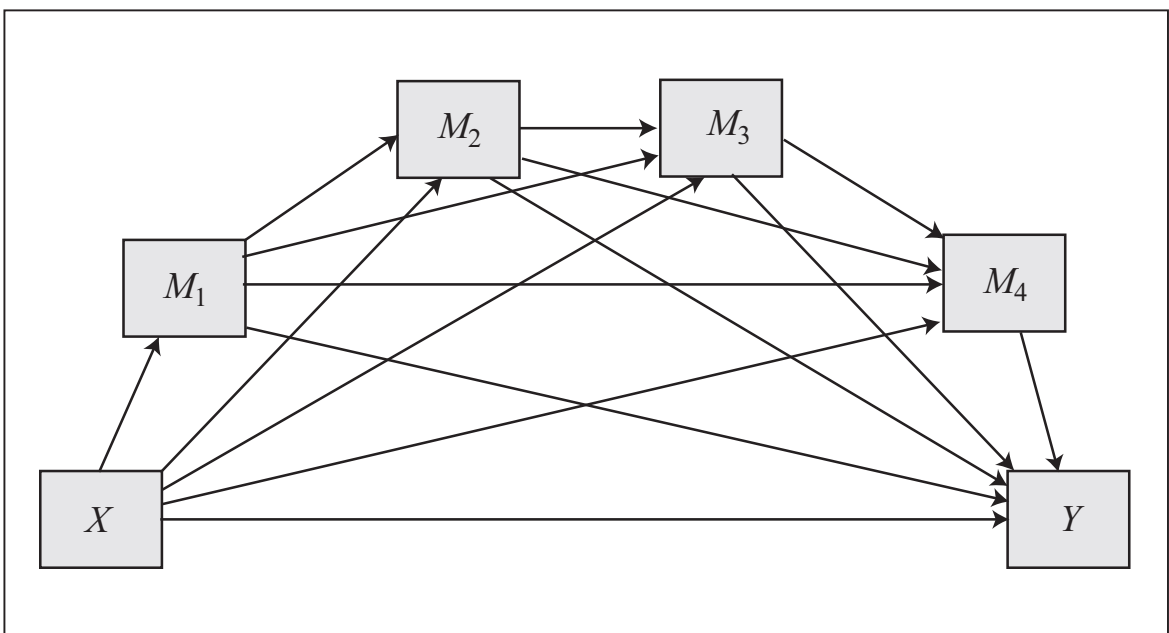

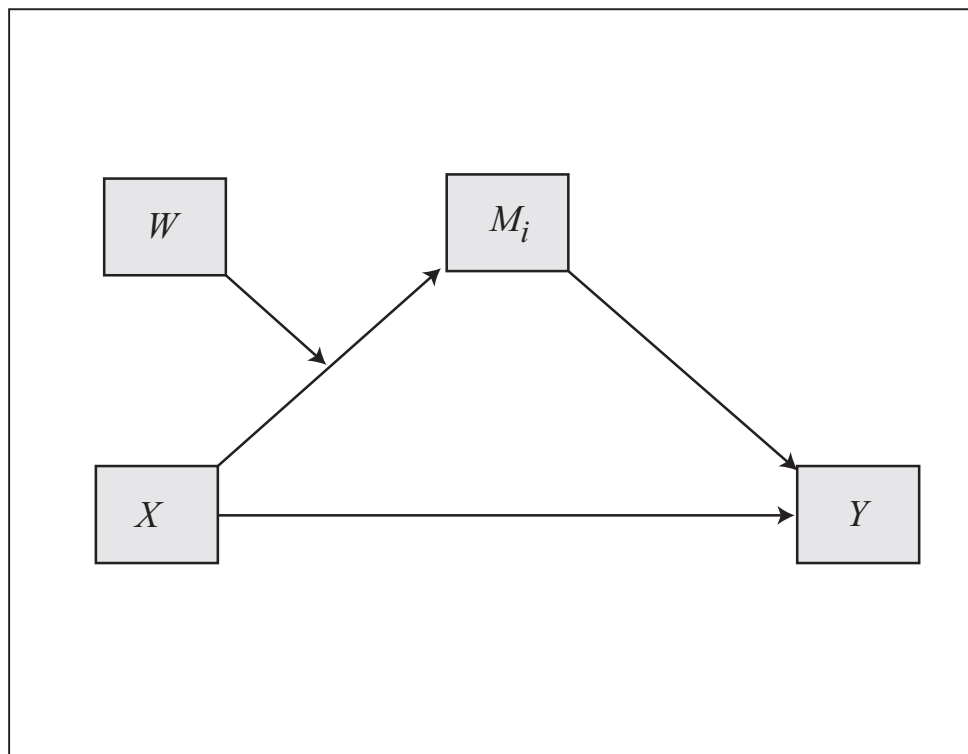
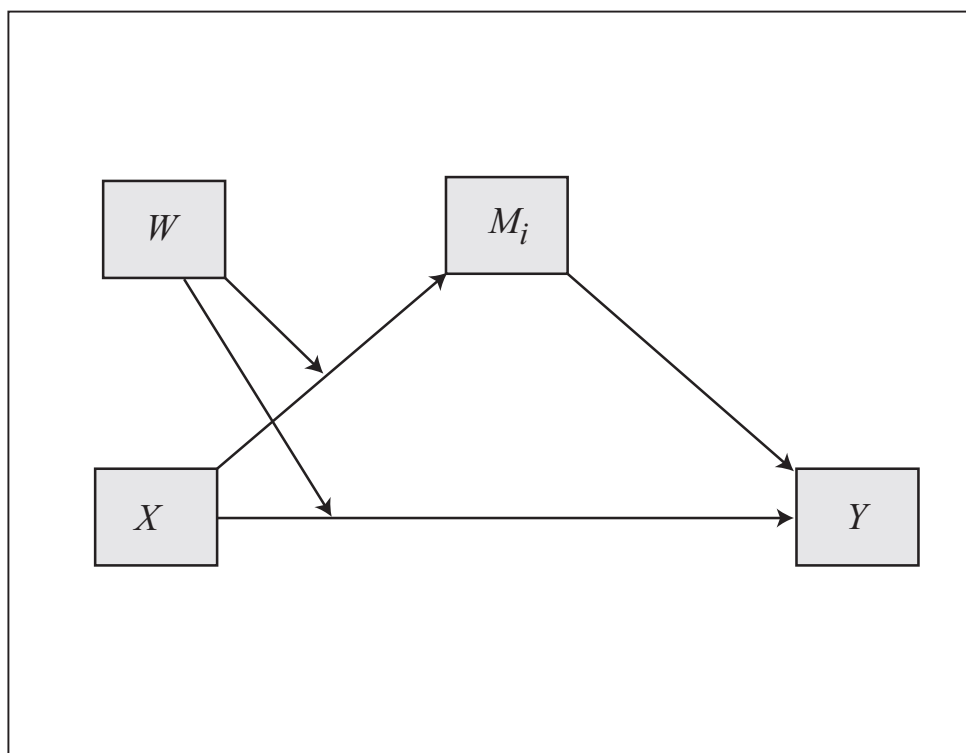
Model 7**Model 8**

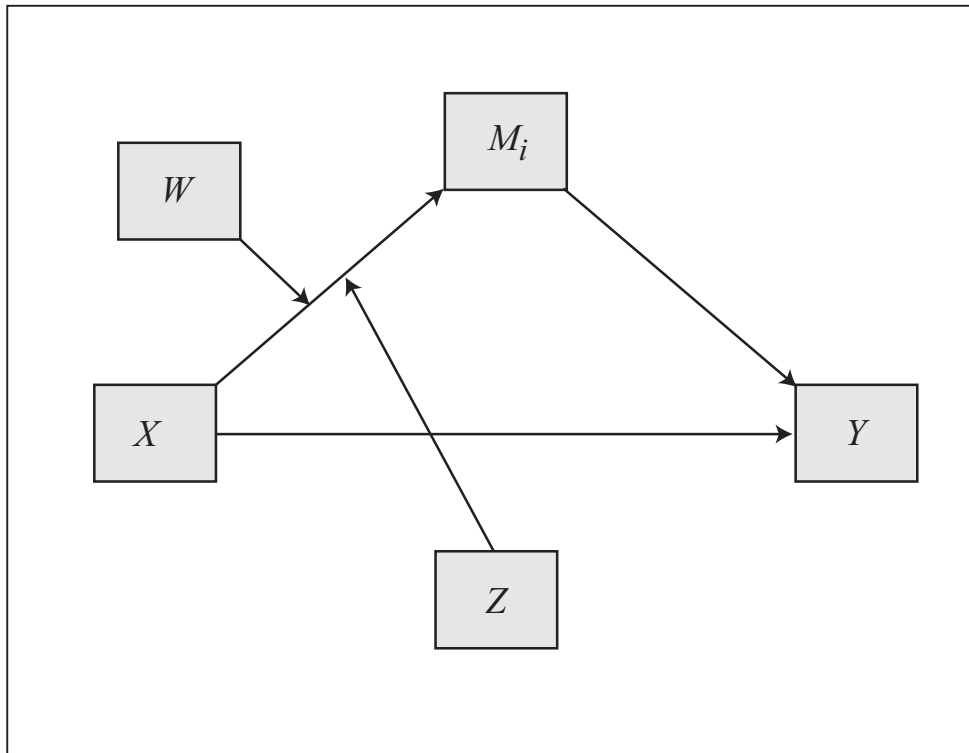
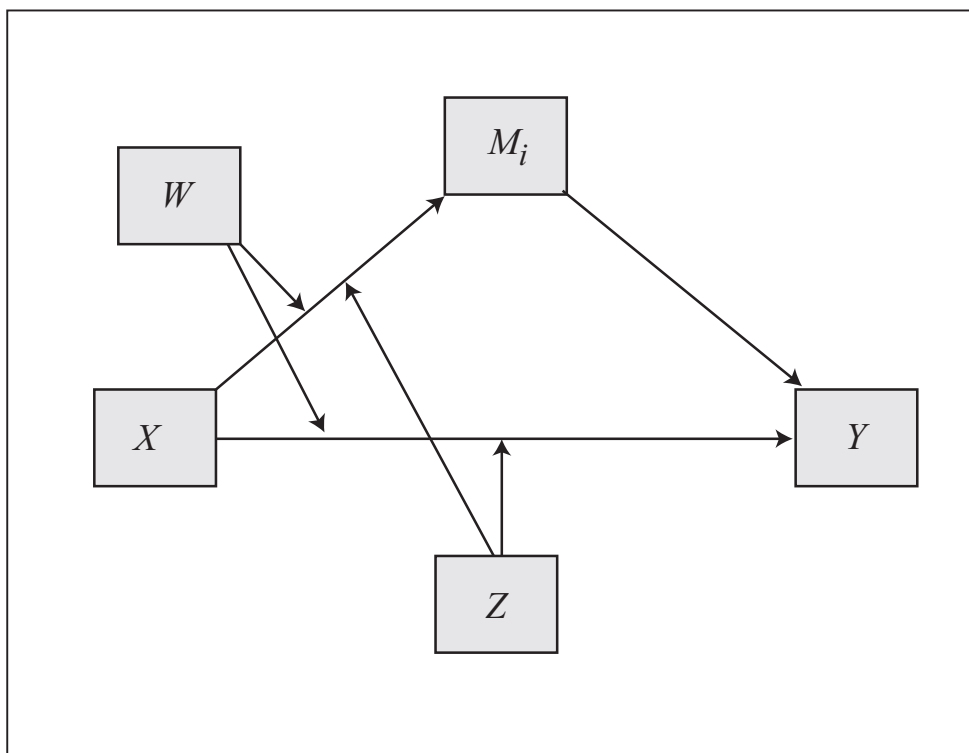
Model 9**Model 10**

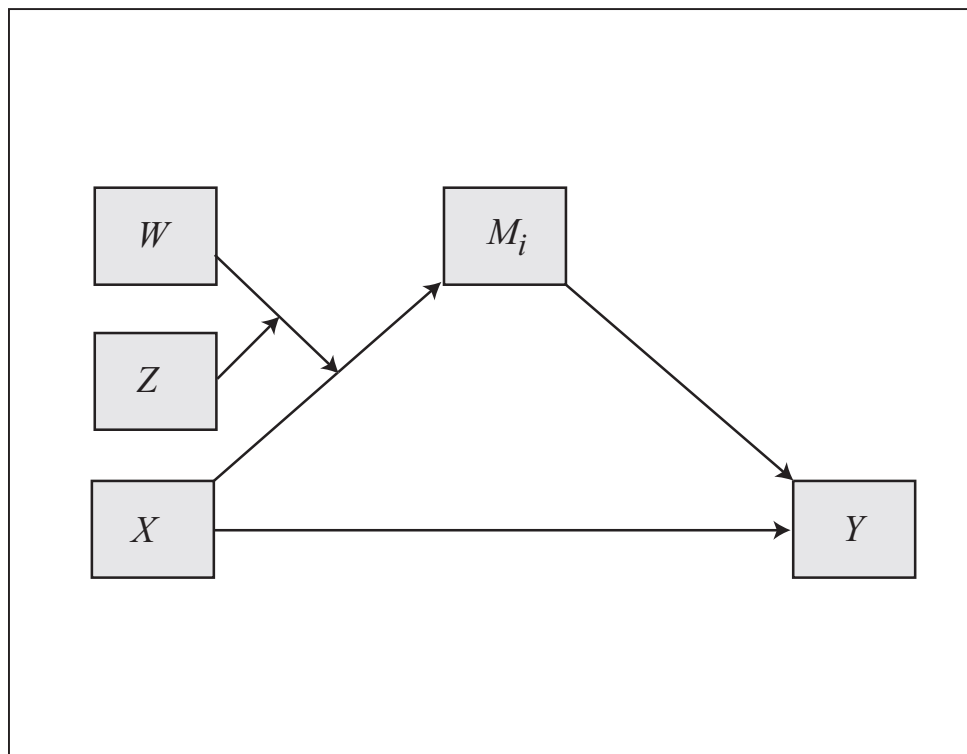
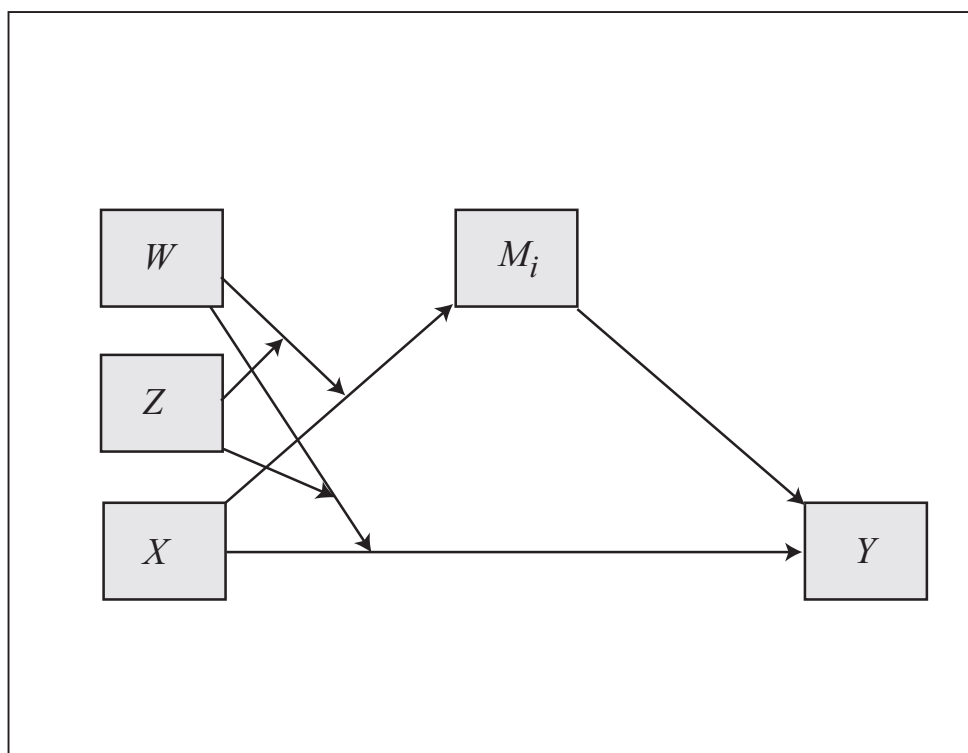
Model 11**Model 12**

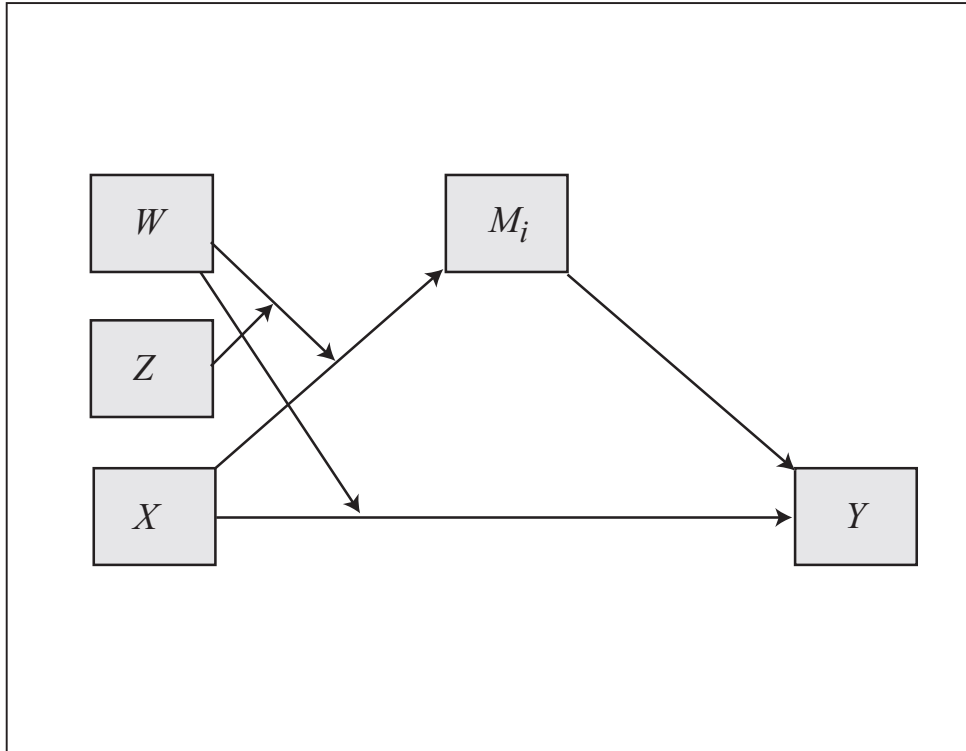
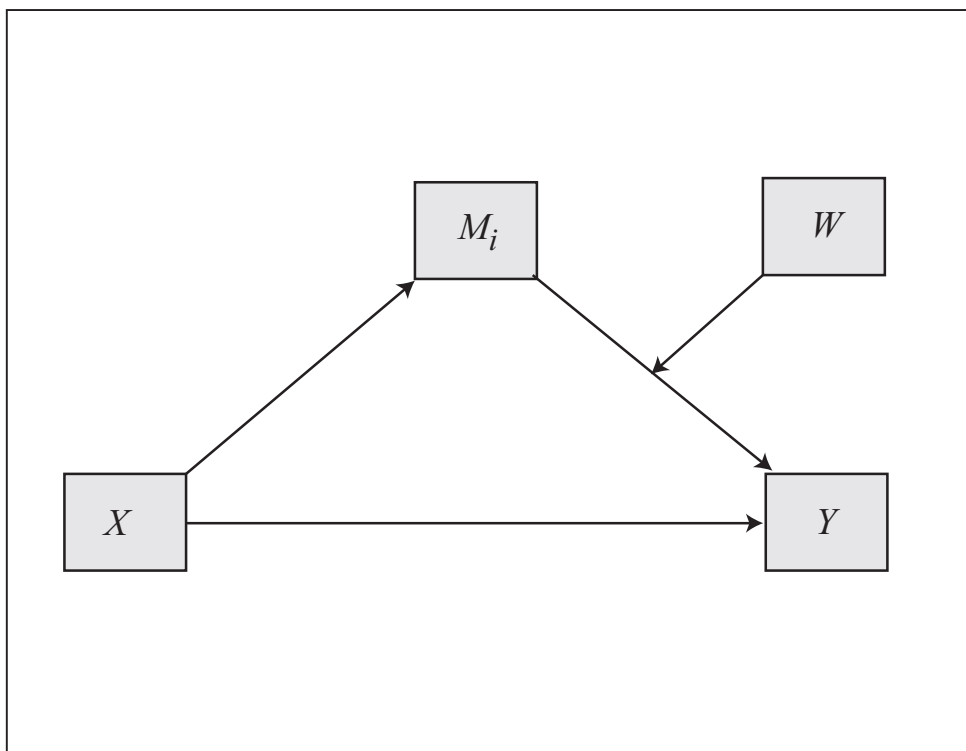
Model 13**Model 14**

Model 15

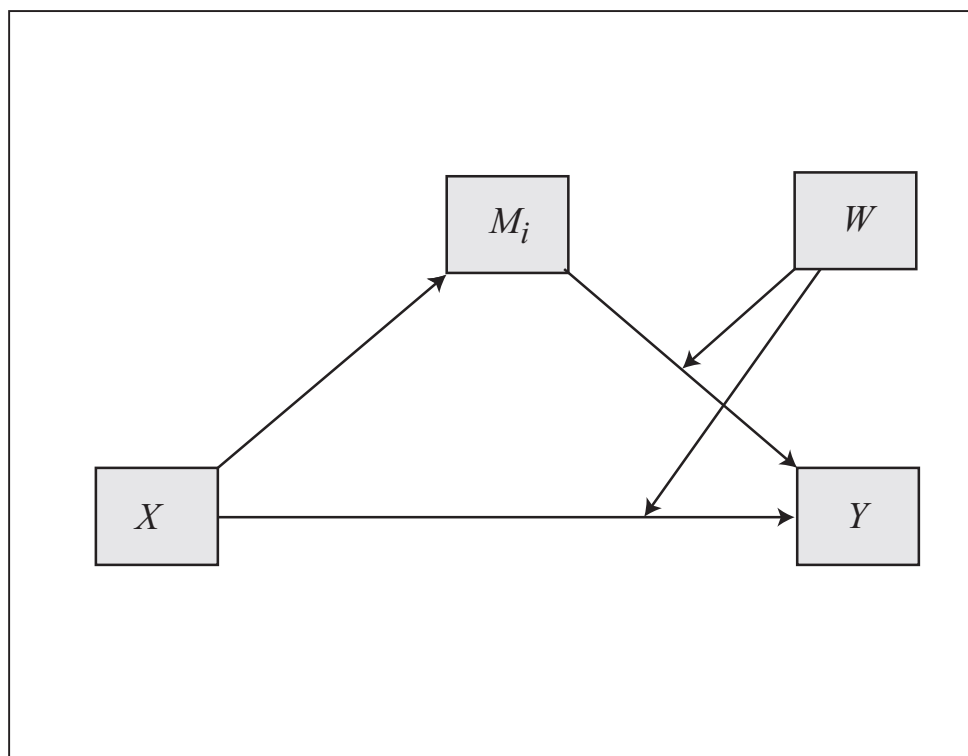

Model 16

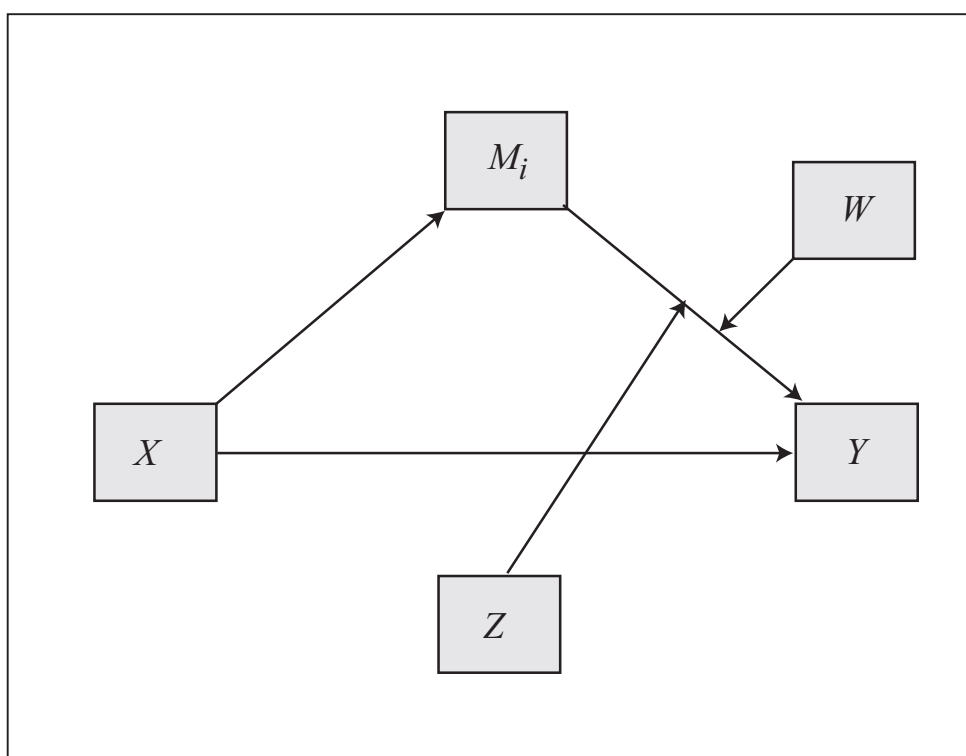

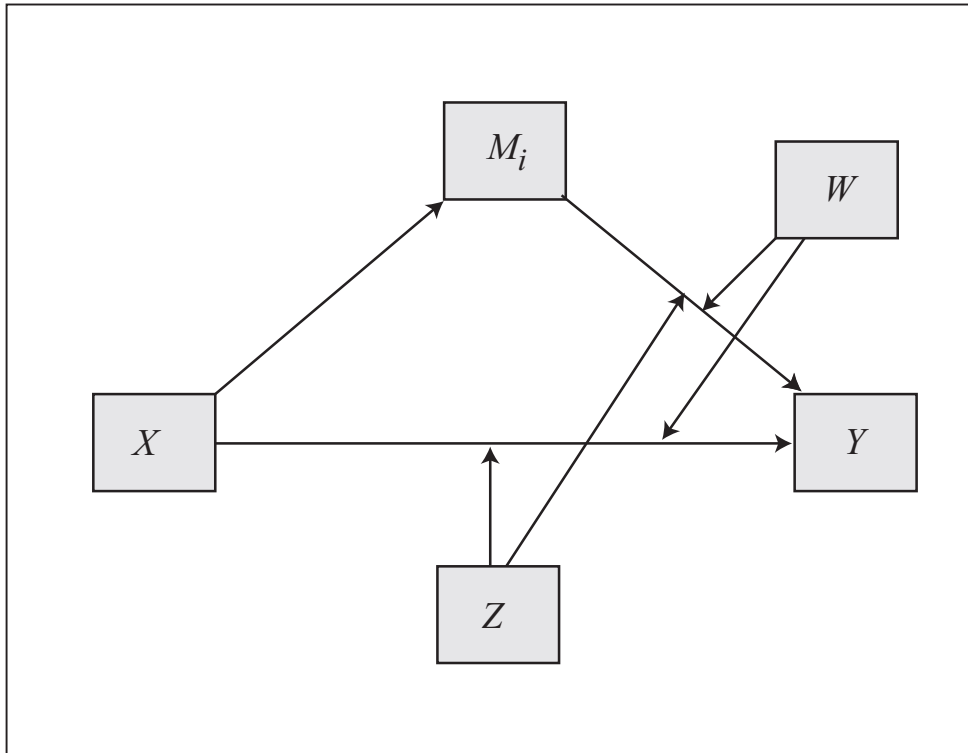
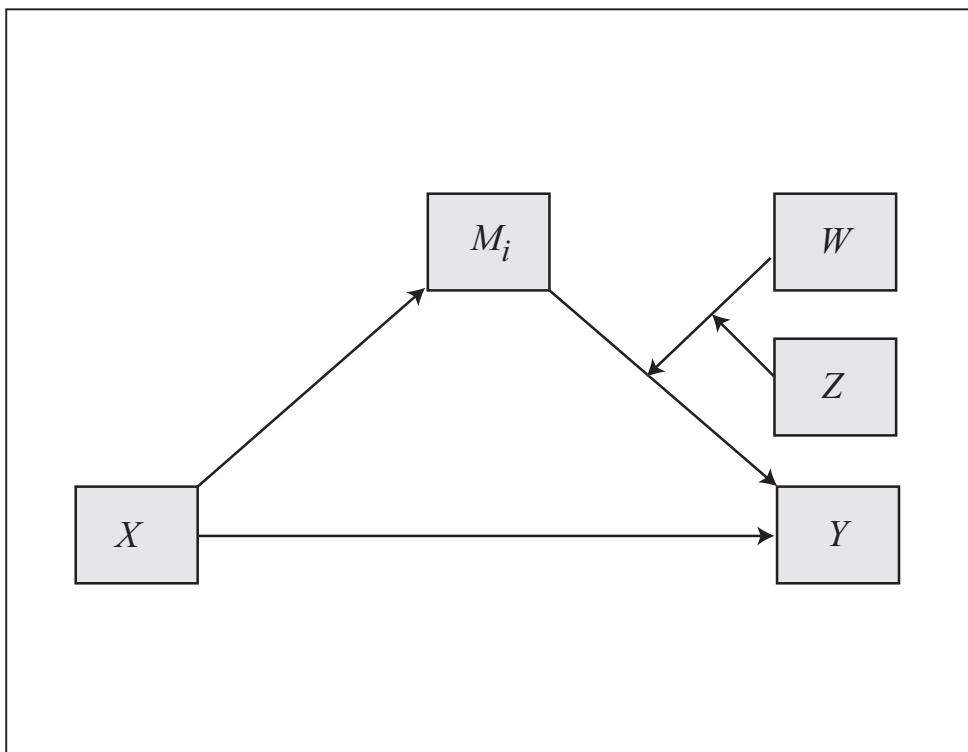
Model 17**Model 18**

Model 19

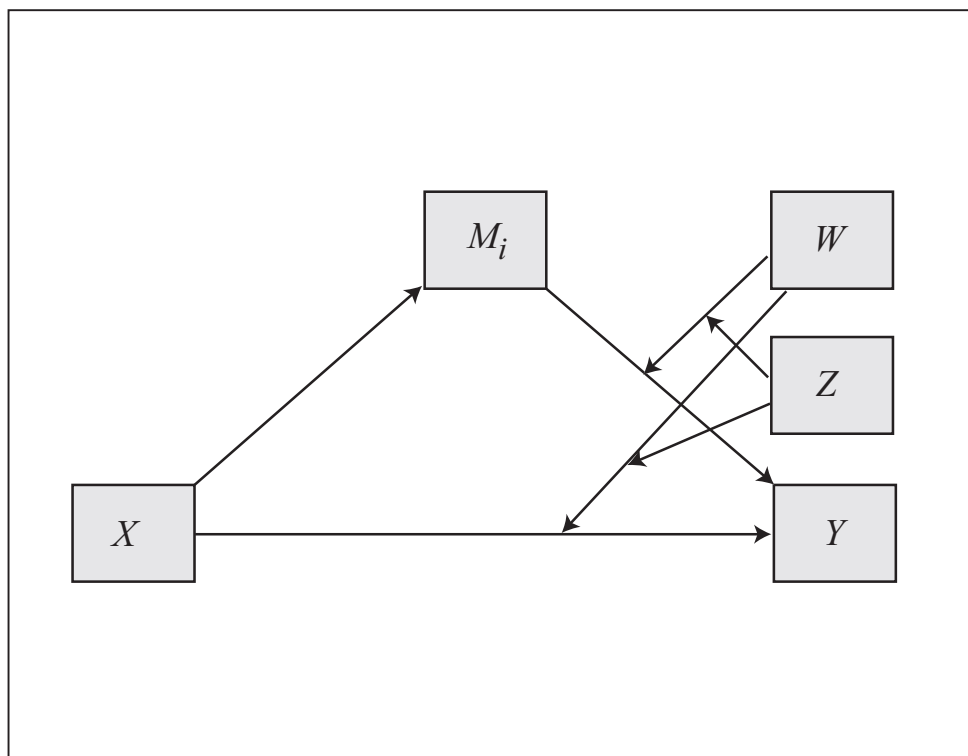

Model 20

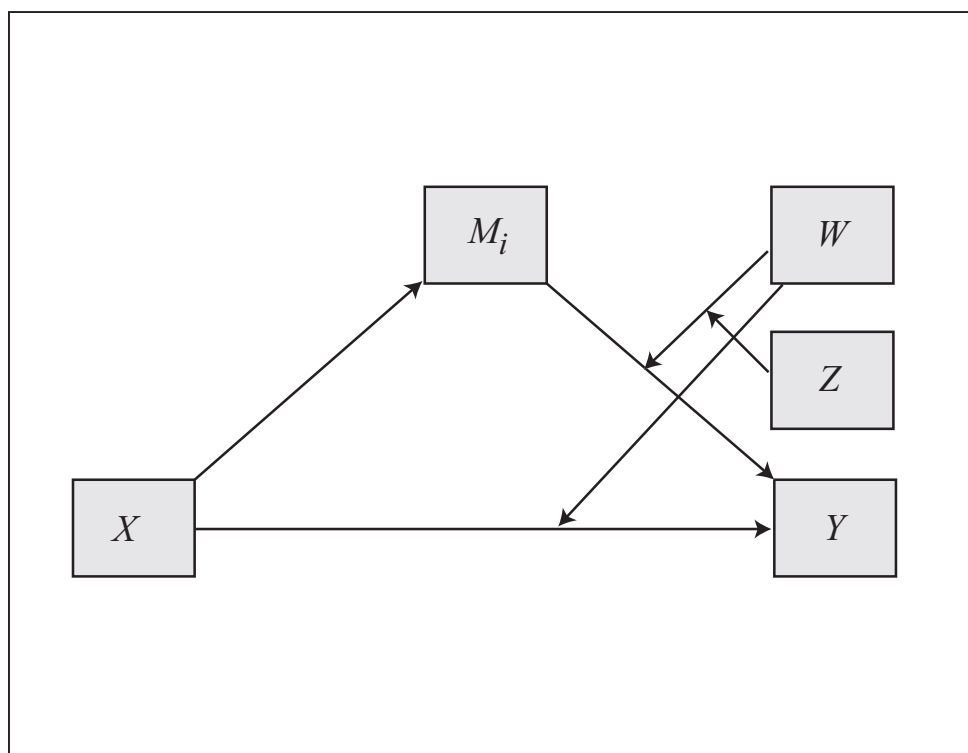

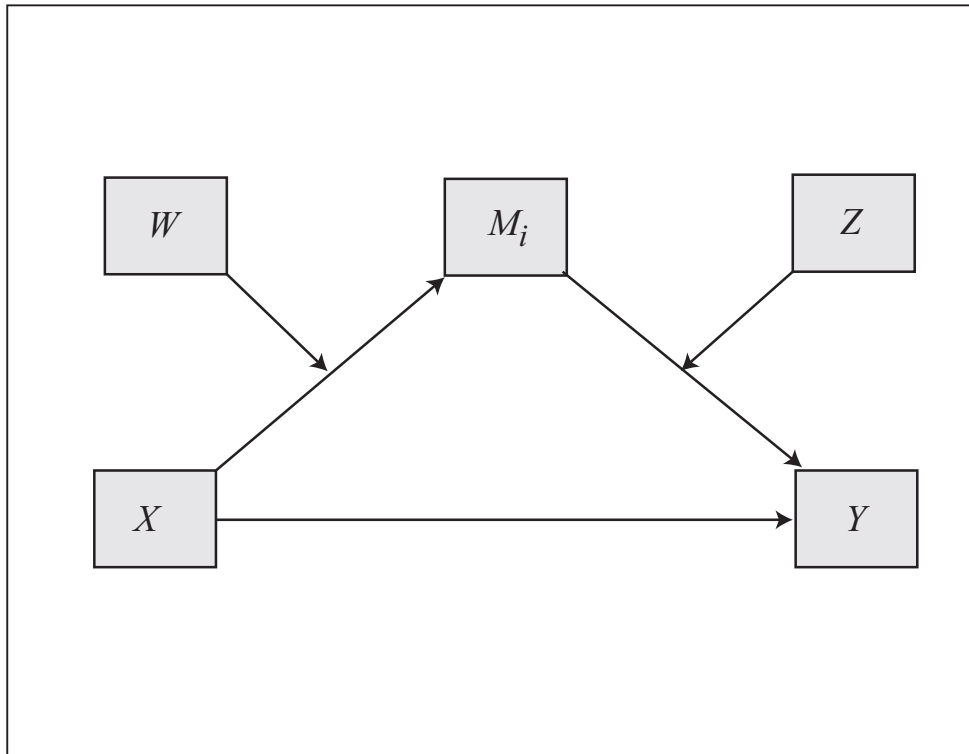
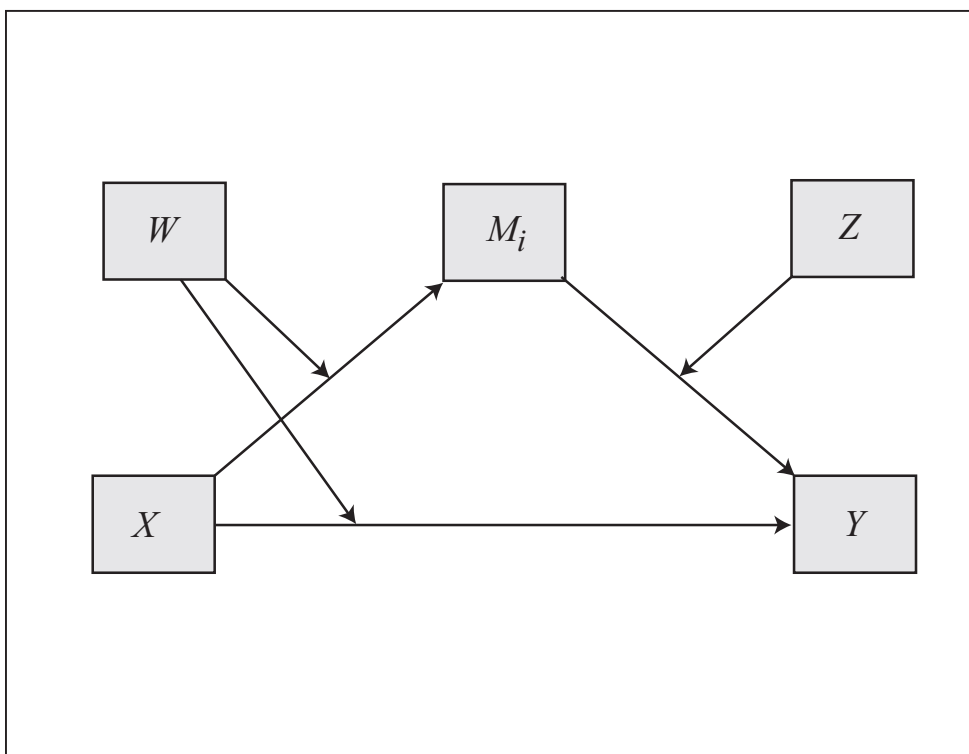
Model 21**Model 22**

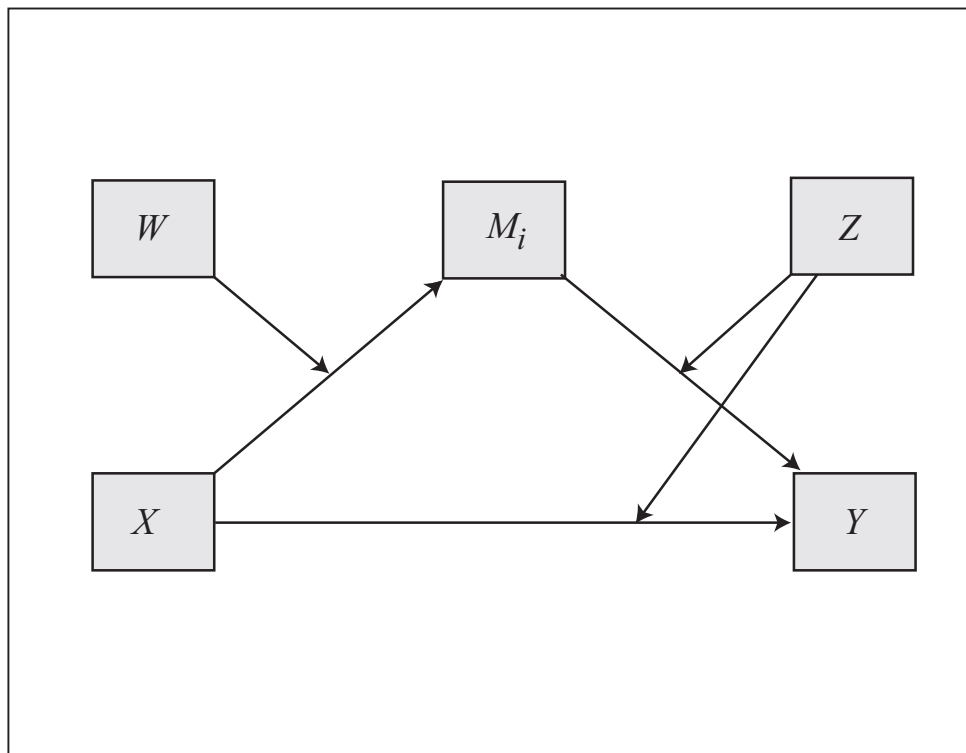
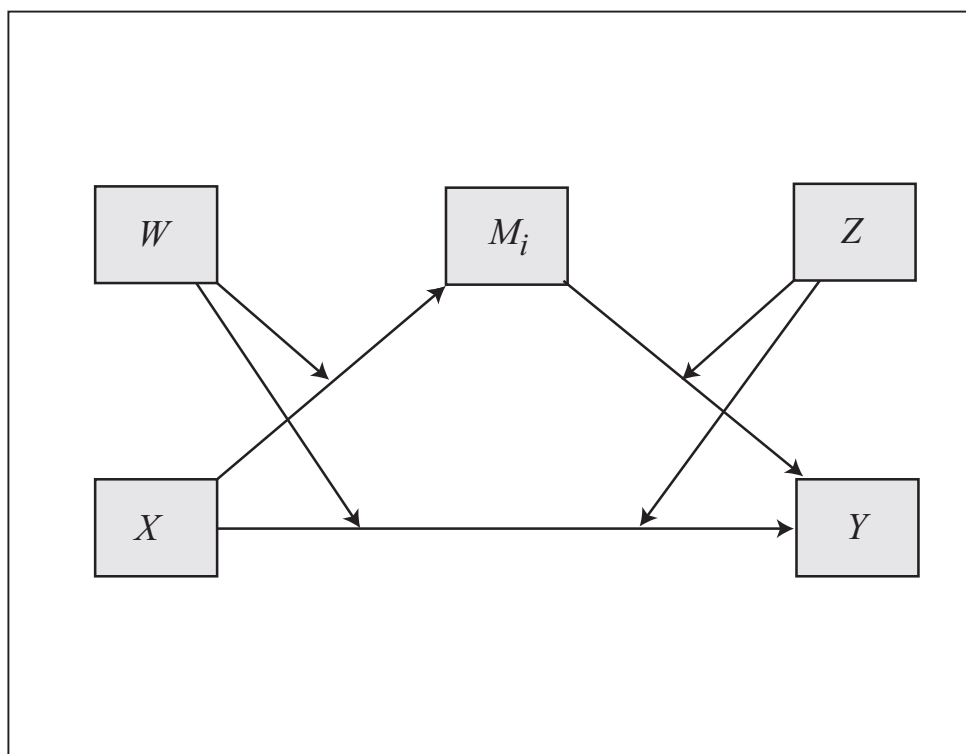
Model 28**Model 29**

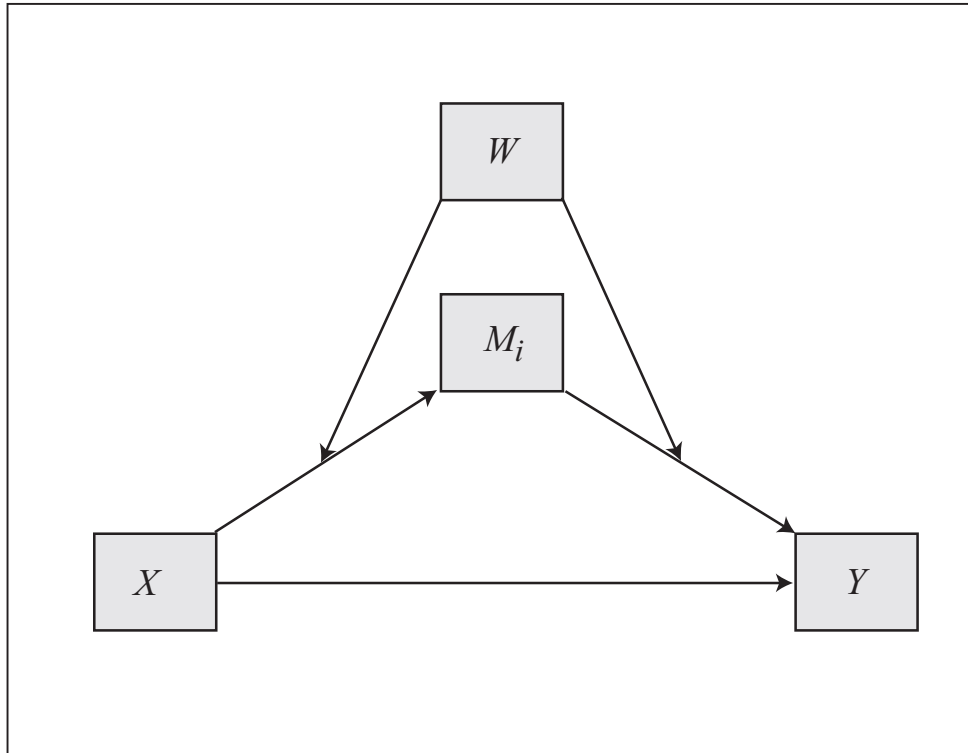
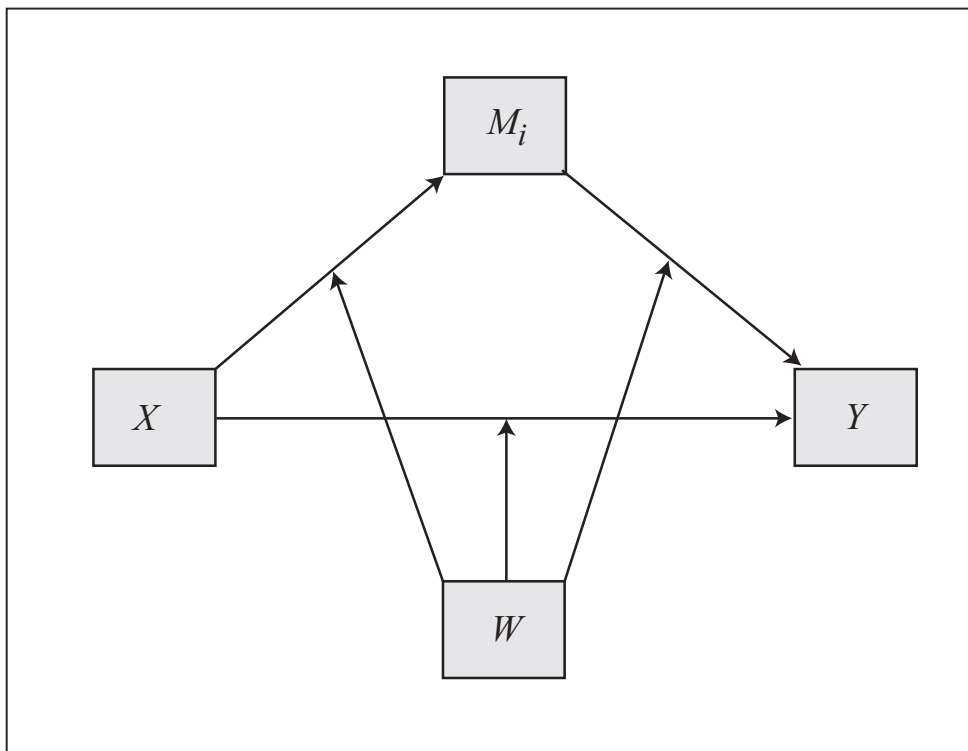
Model 58**Model 59**

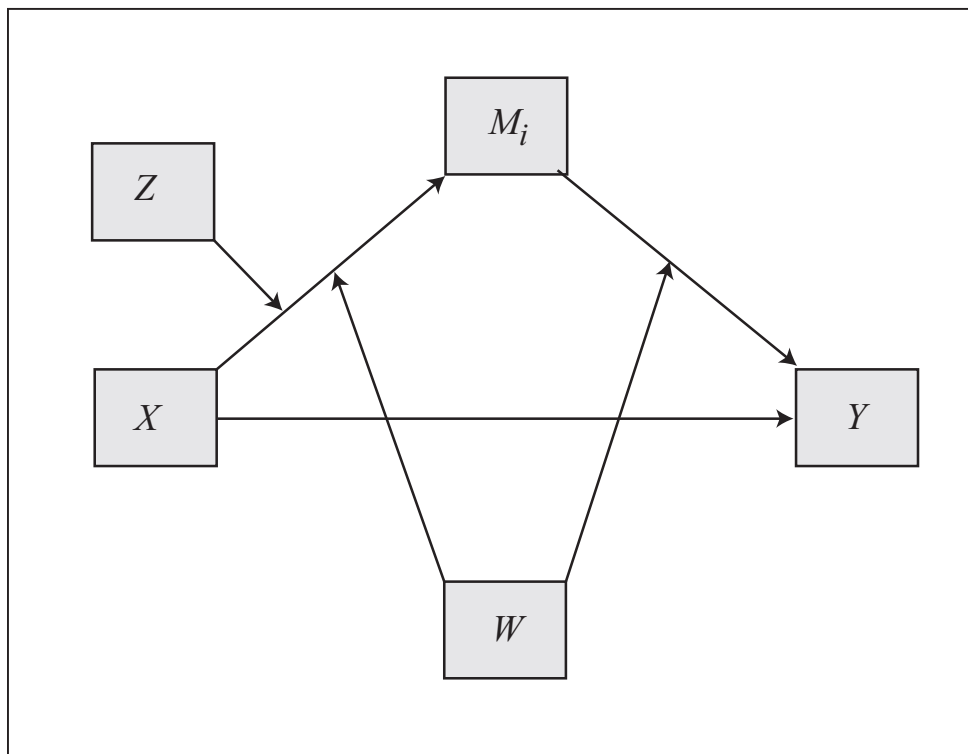
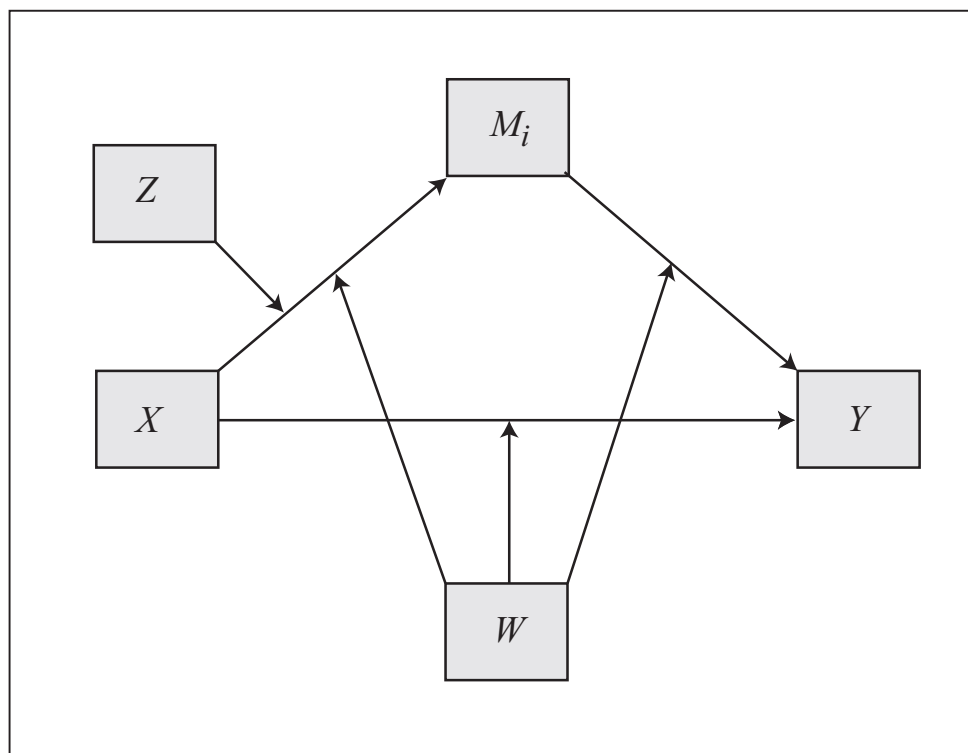
Model 60**Model 61**

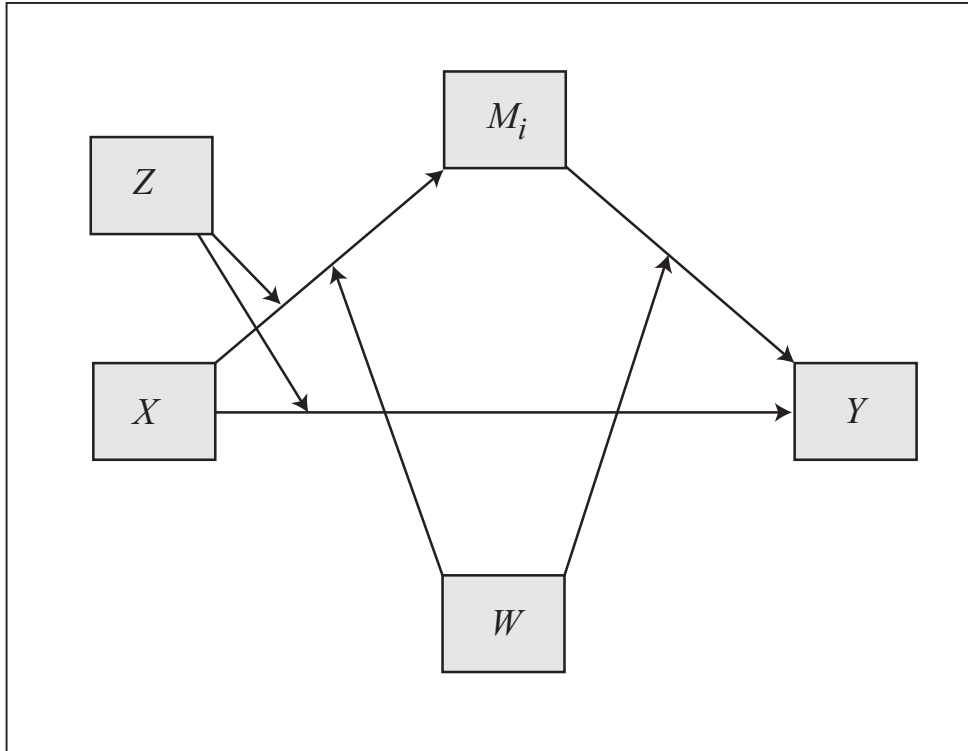
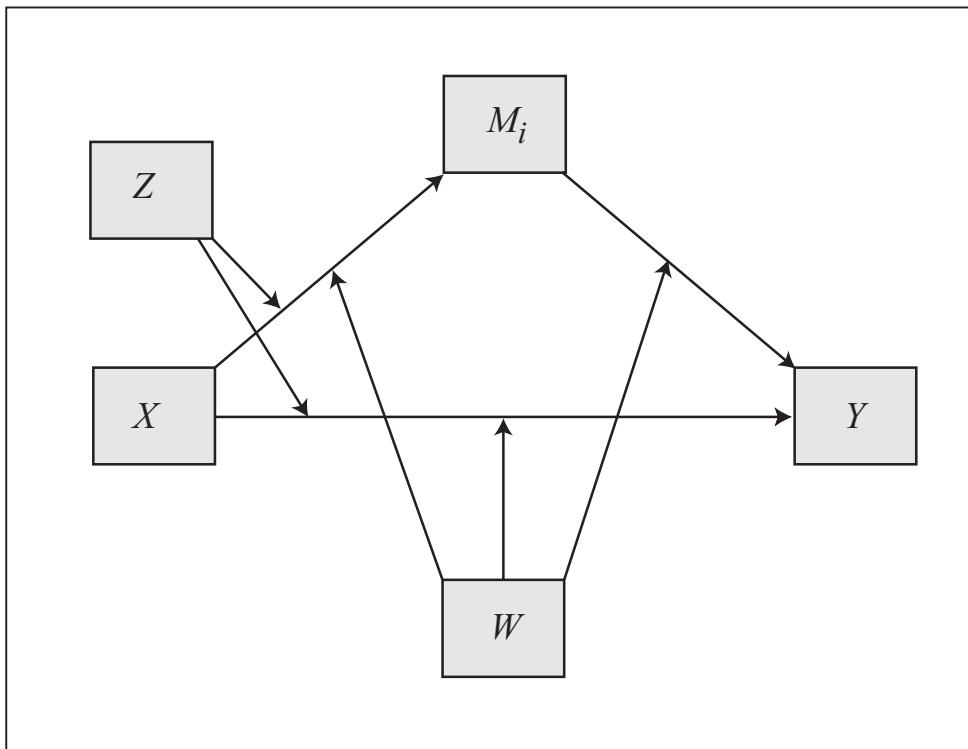
Model 62**Model 63**

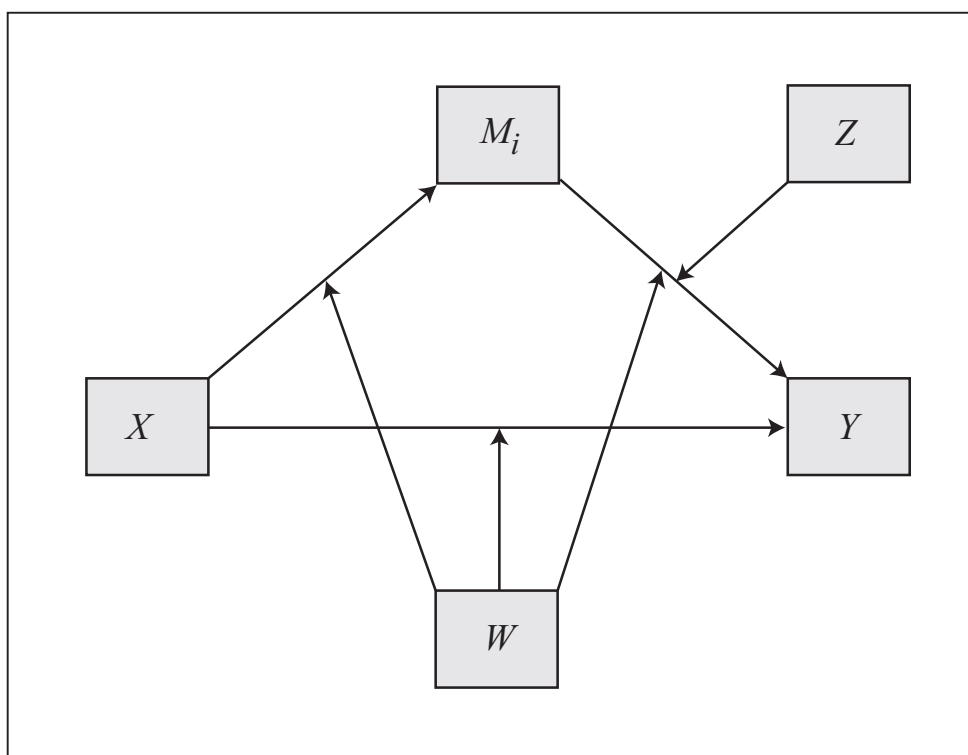
Model 64**Model 65**

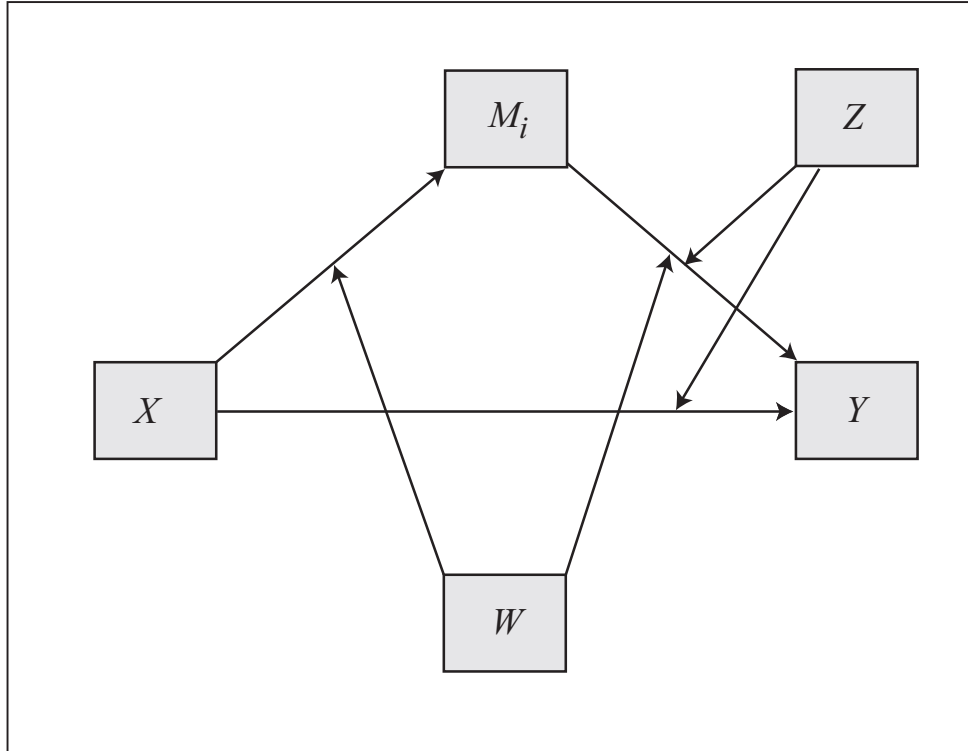
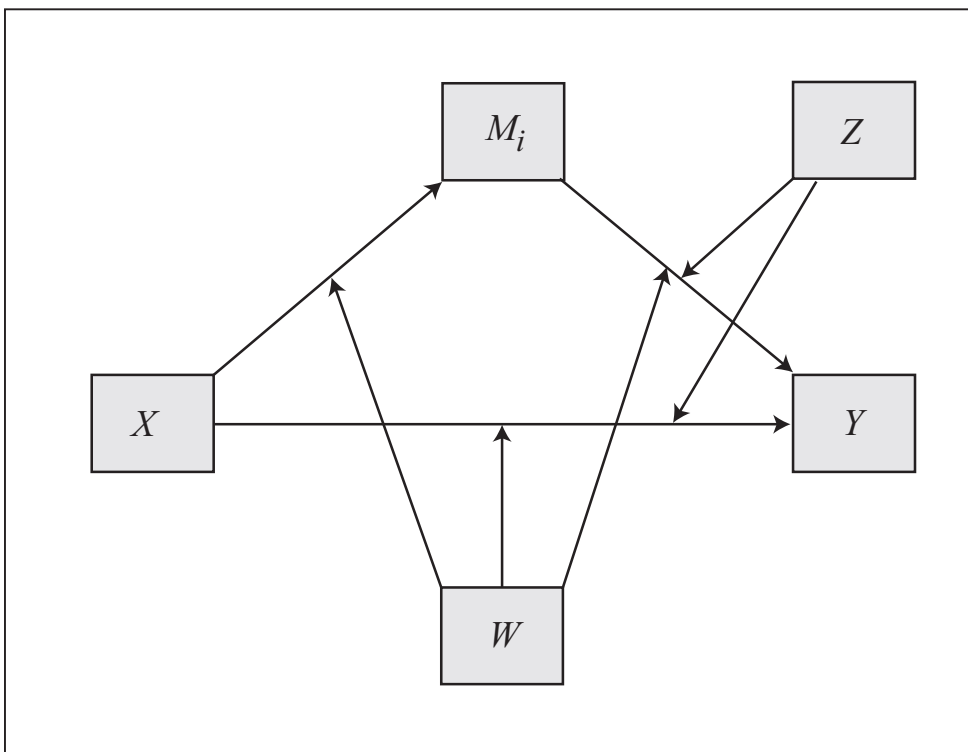
Model 66**Model 67**

Model 68

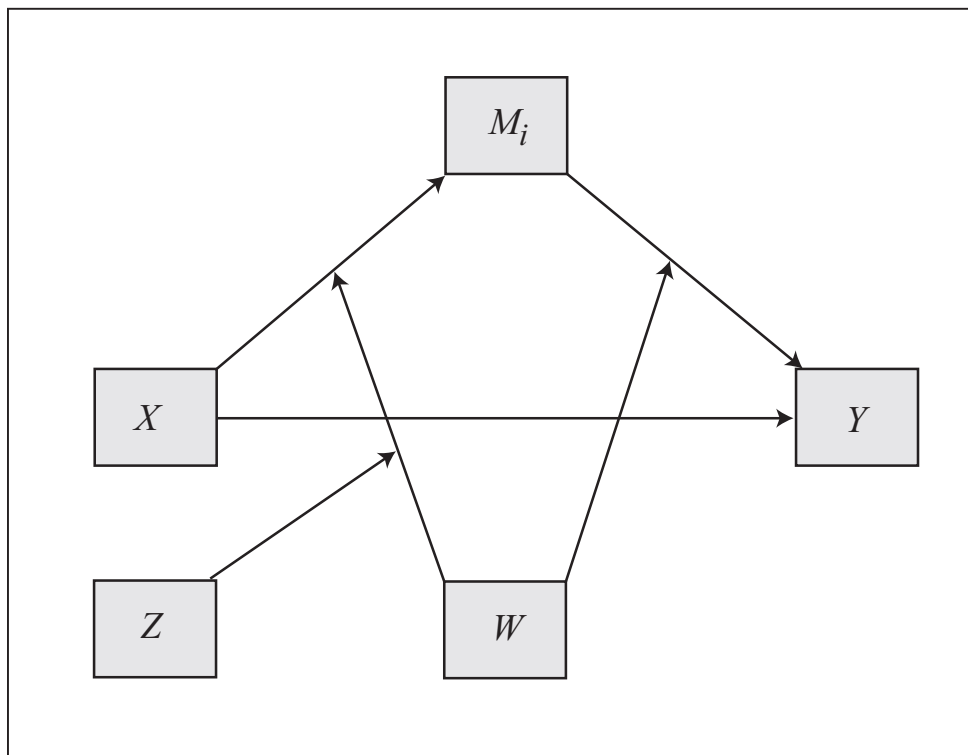

Model 69

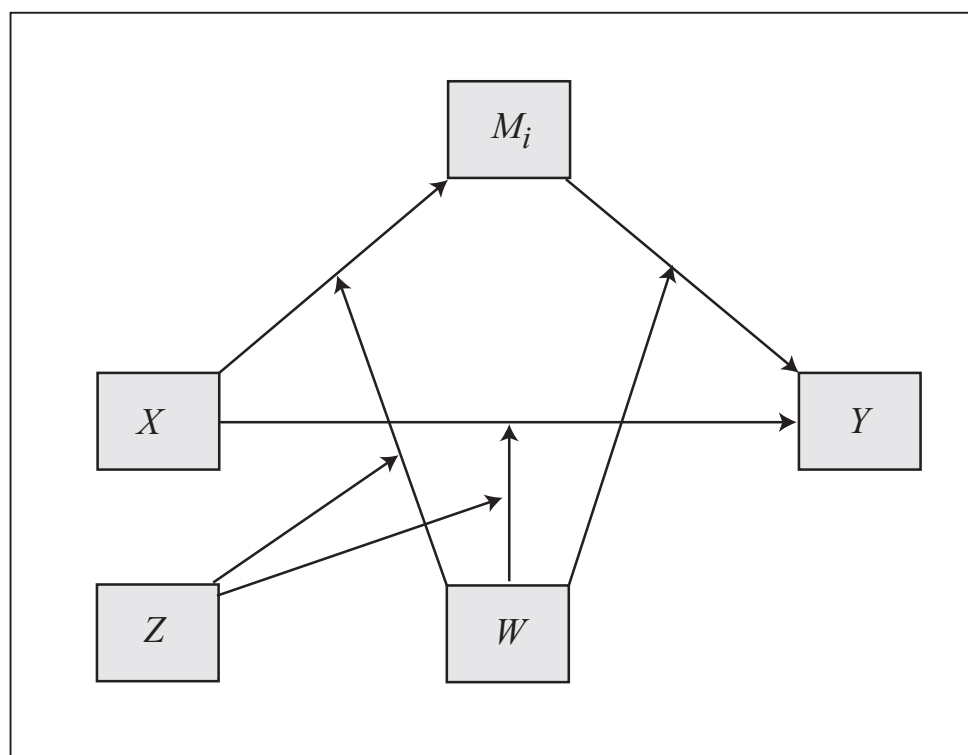

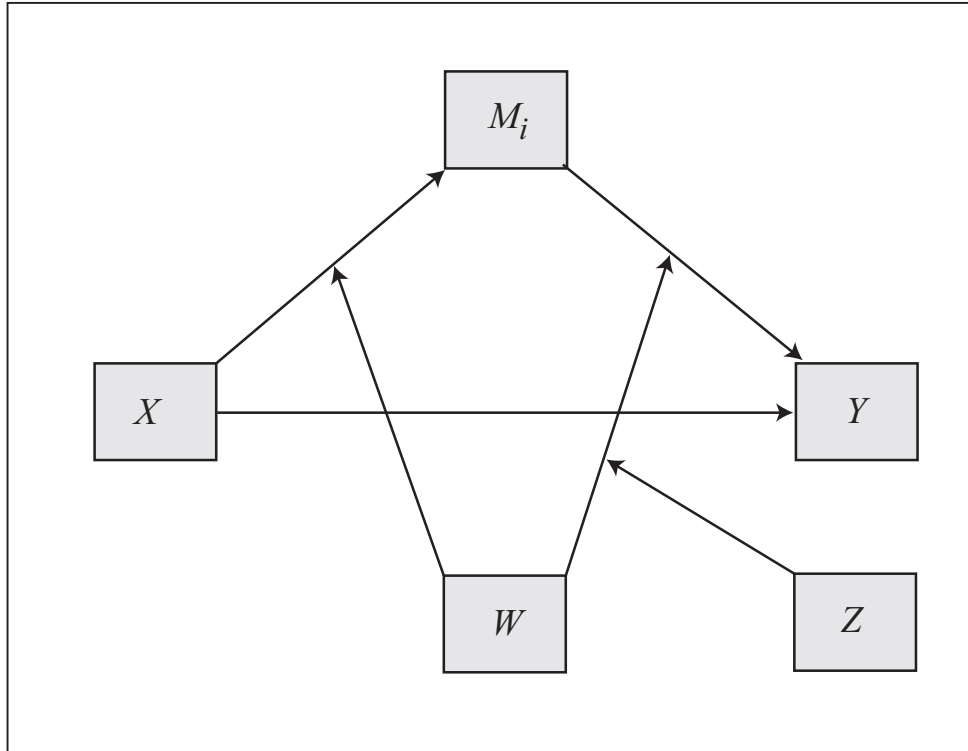
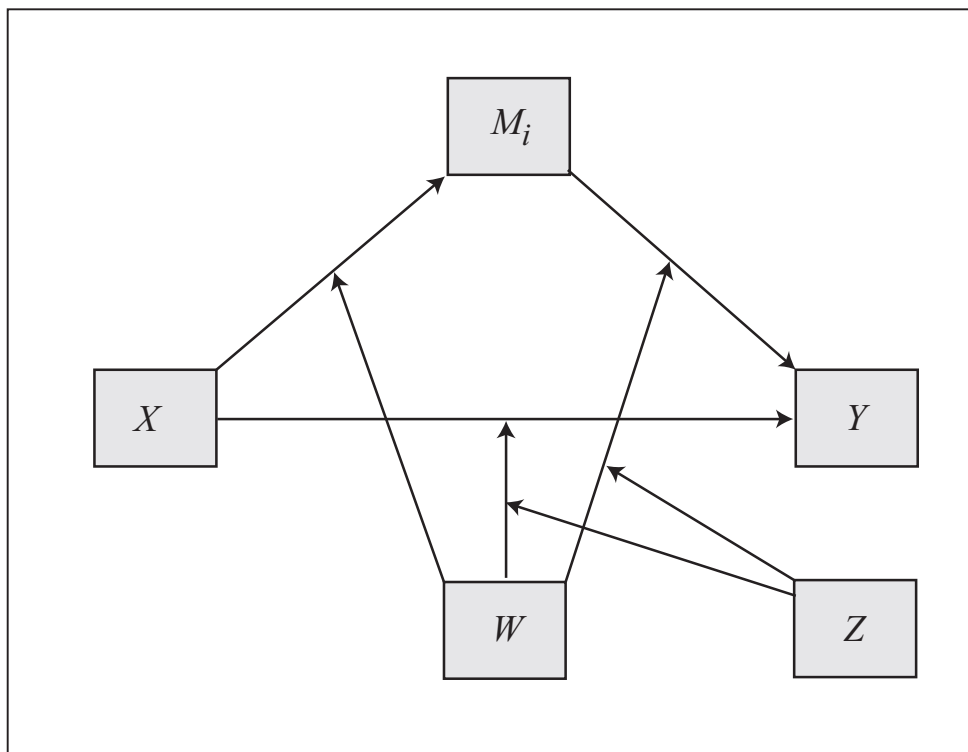
Model 70**Model 71**

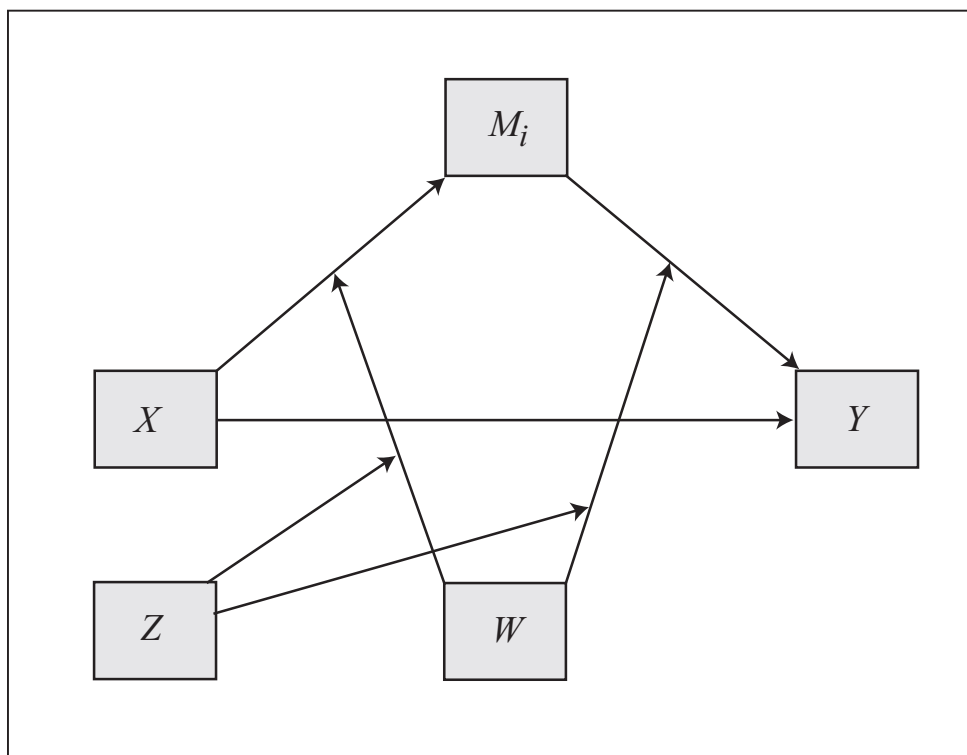
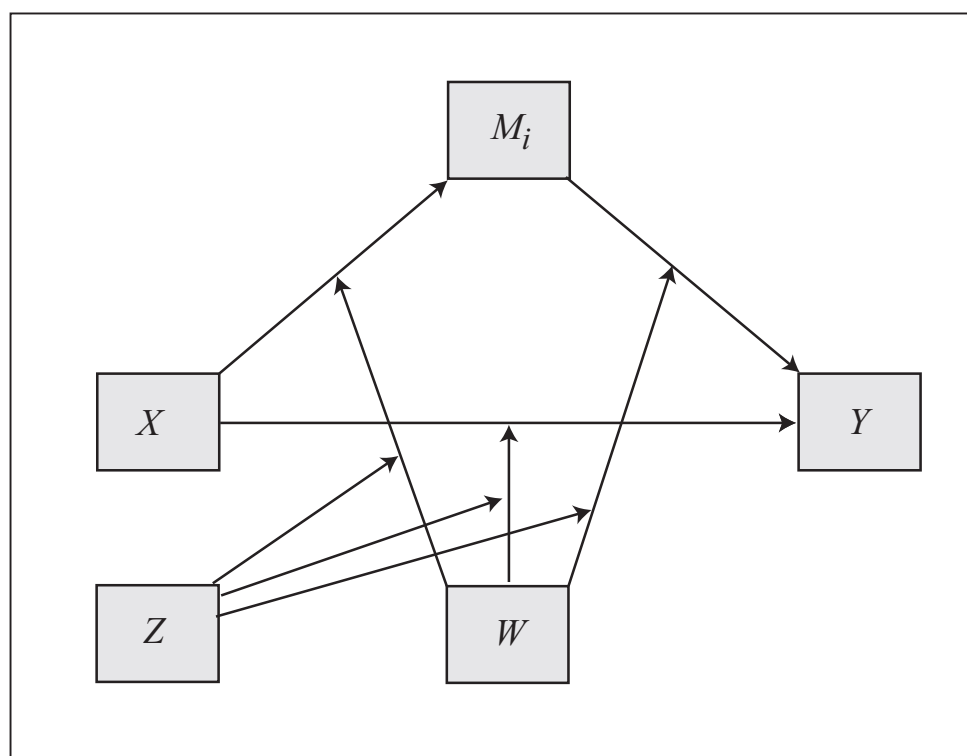
Model 72**Model 73**

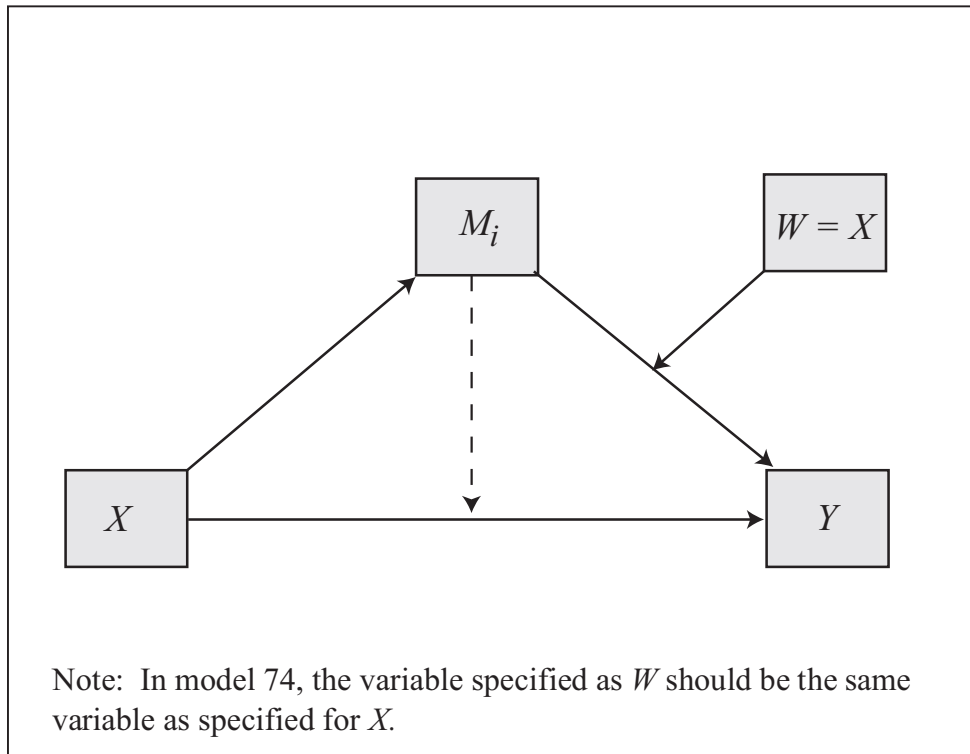
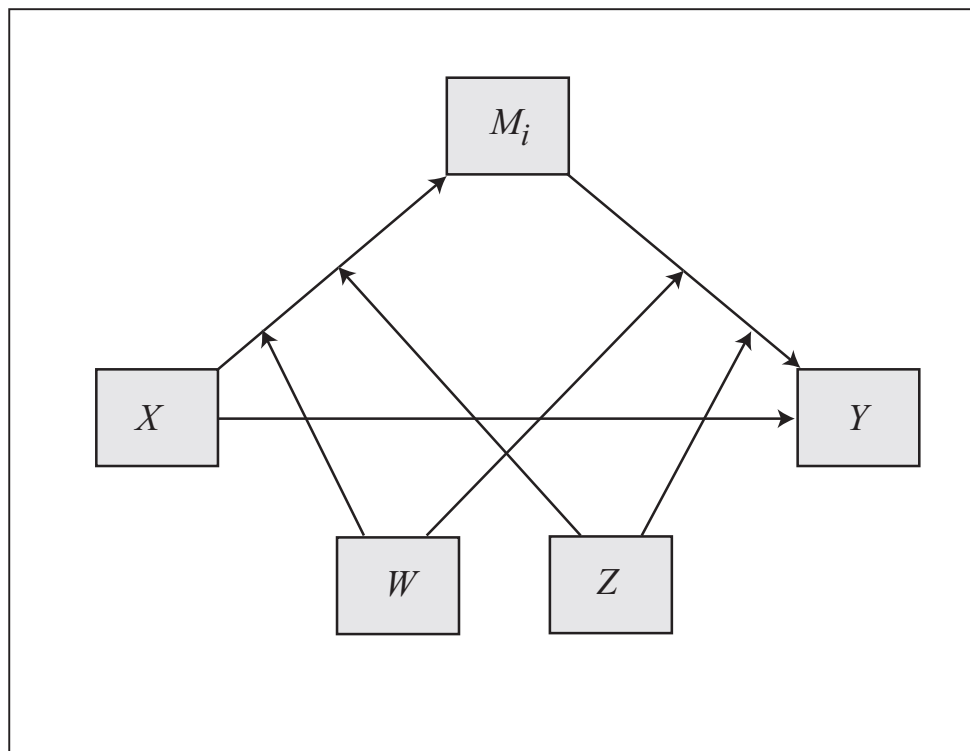
Model 74**Model 75**

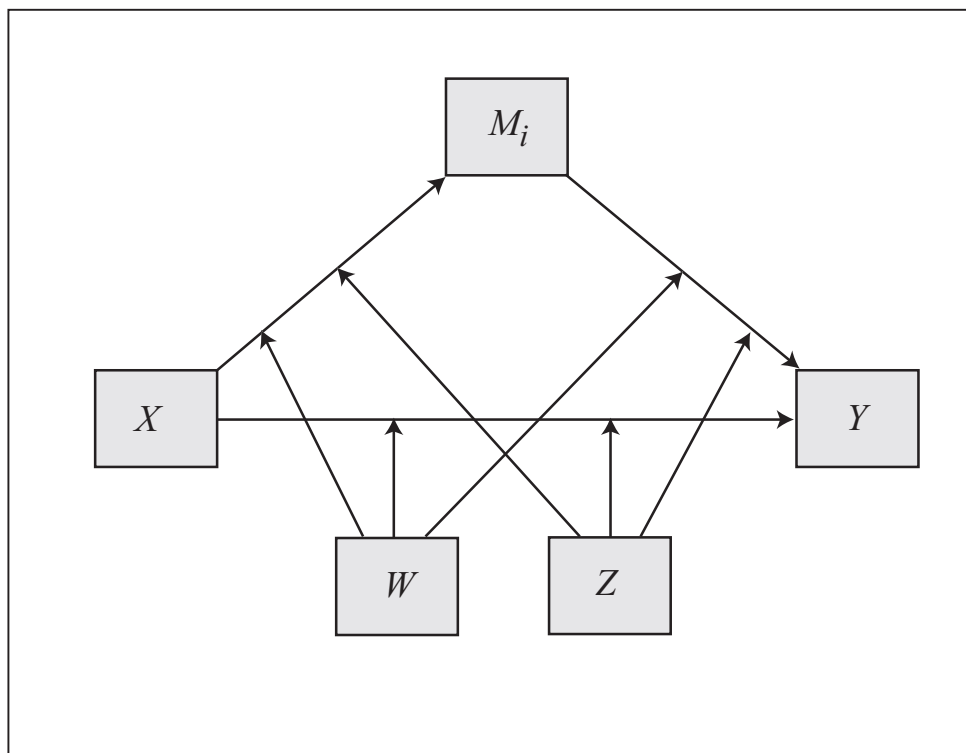
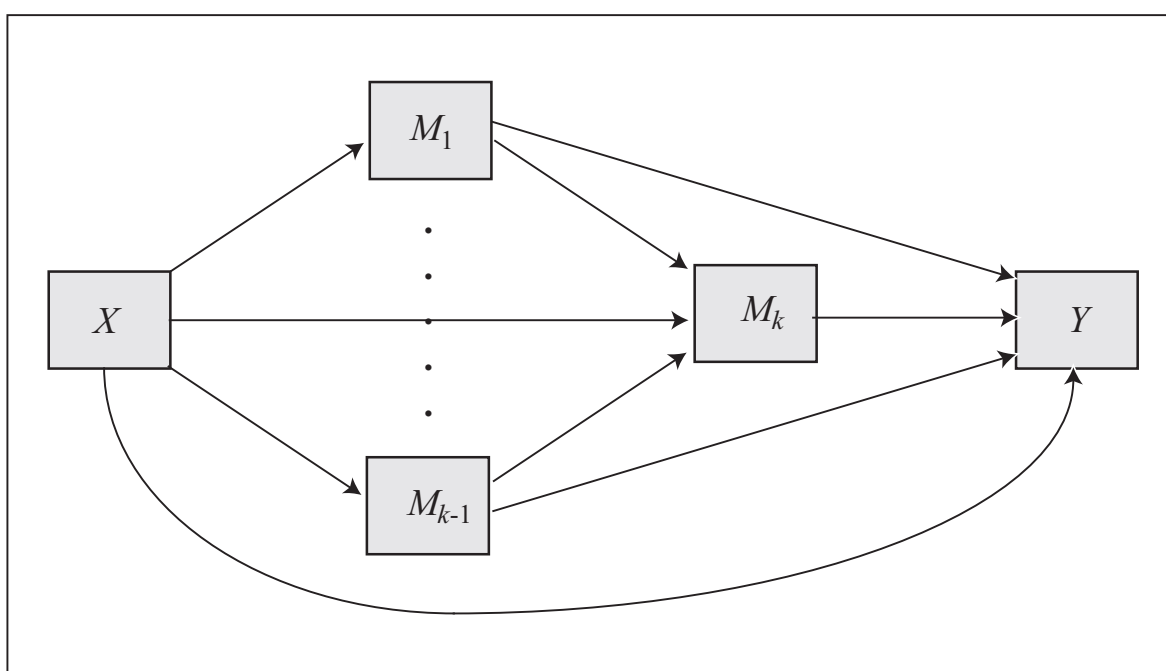
Model 76**Model 80**

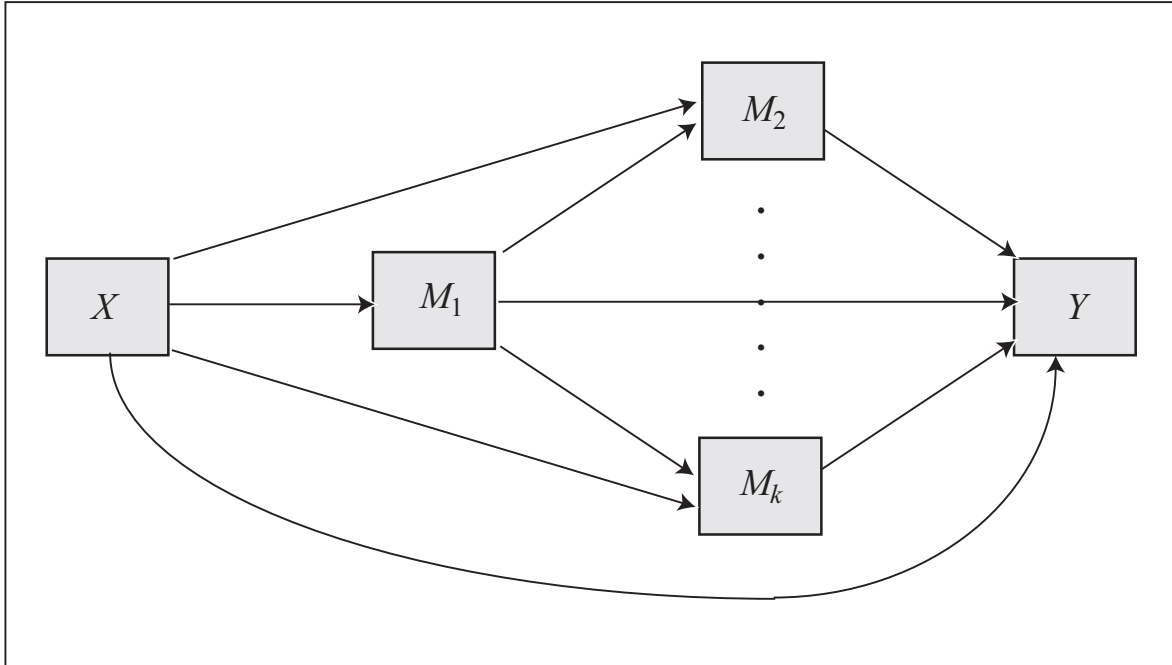
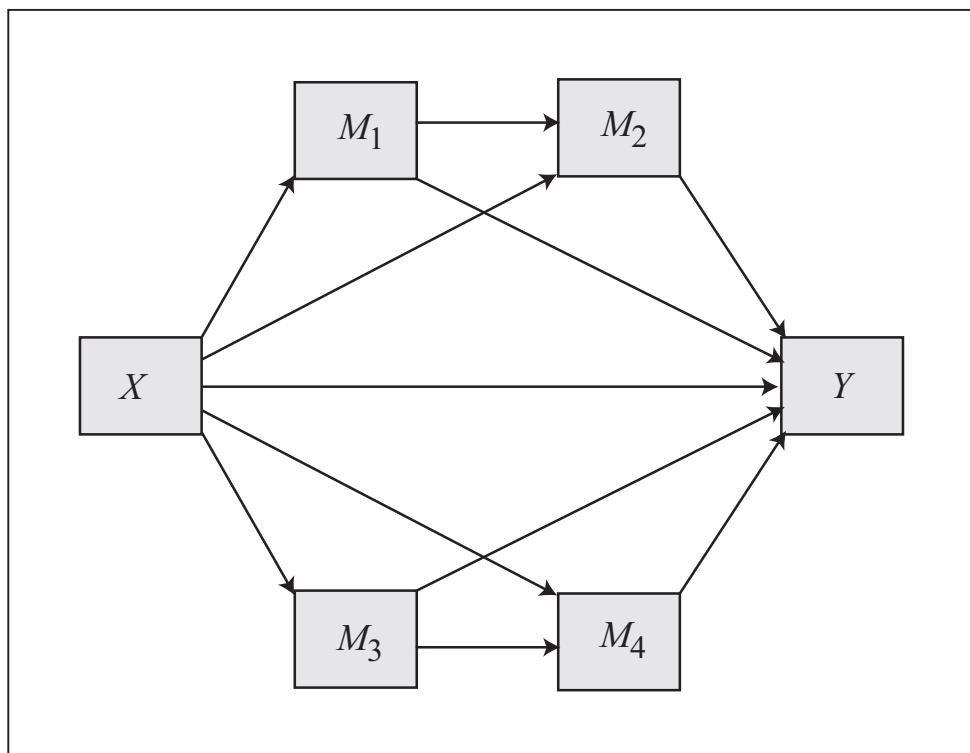
Model 81**Model 82**

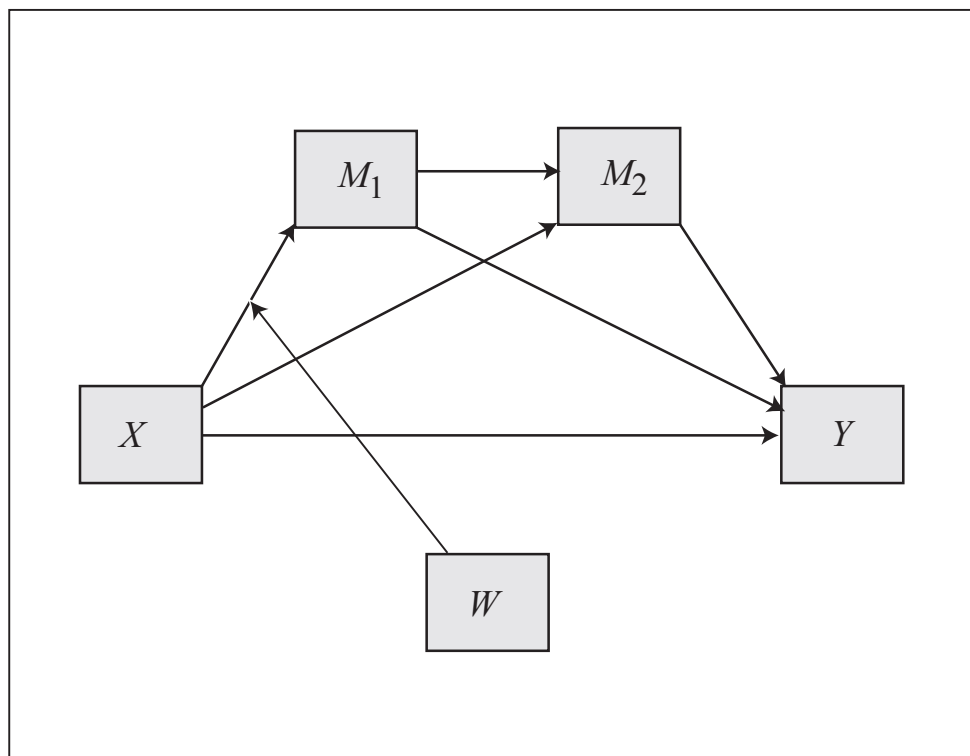
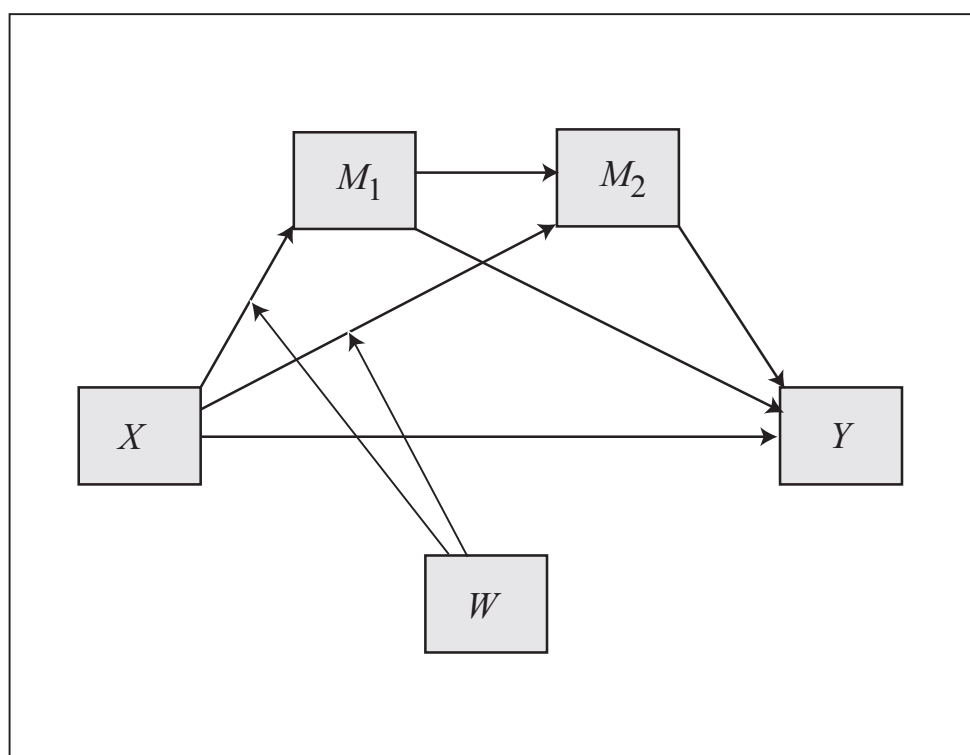
Model 83**Model 84**

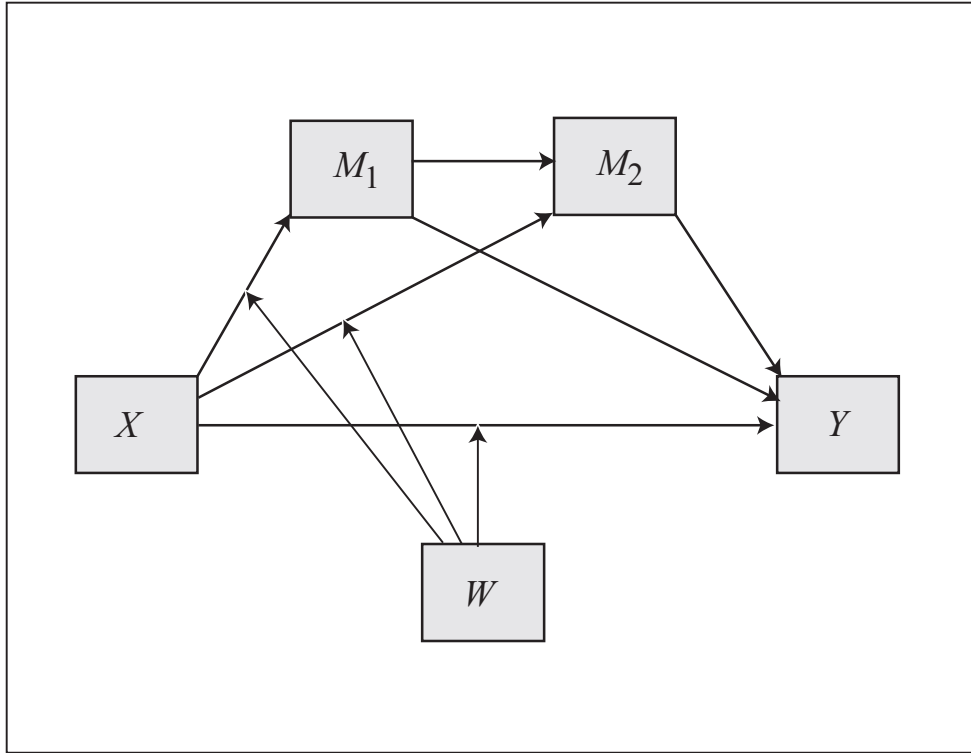
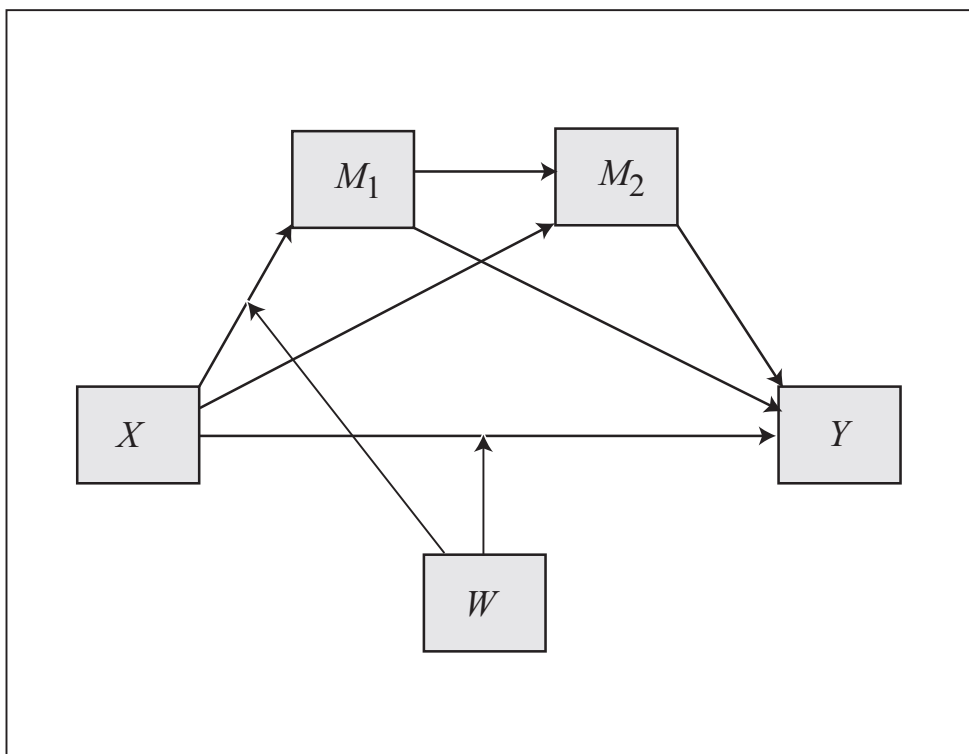
Model 85**Model 86**

Model 87

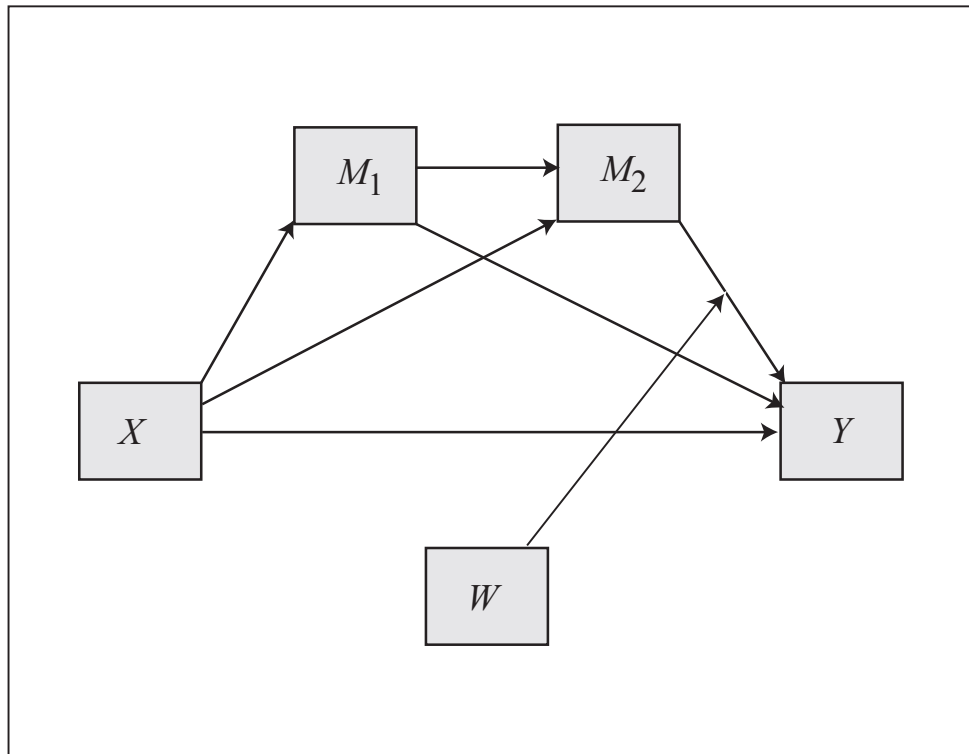

Model 88

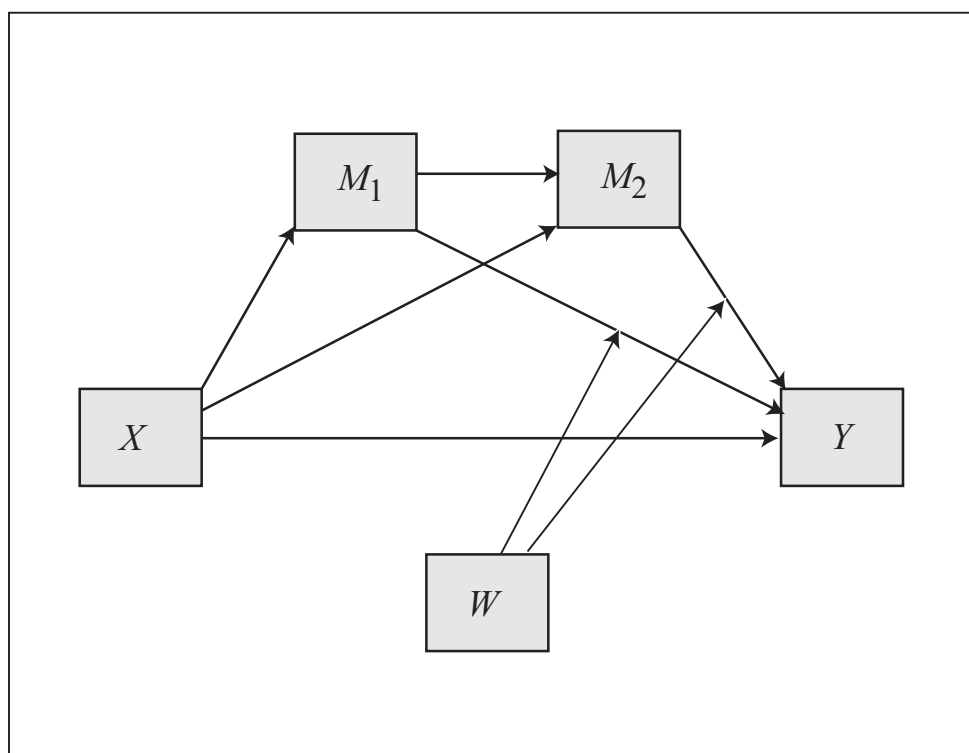

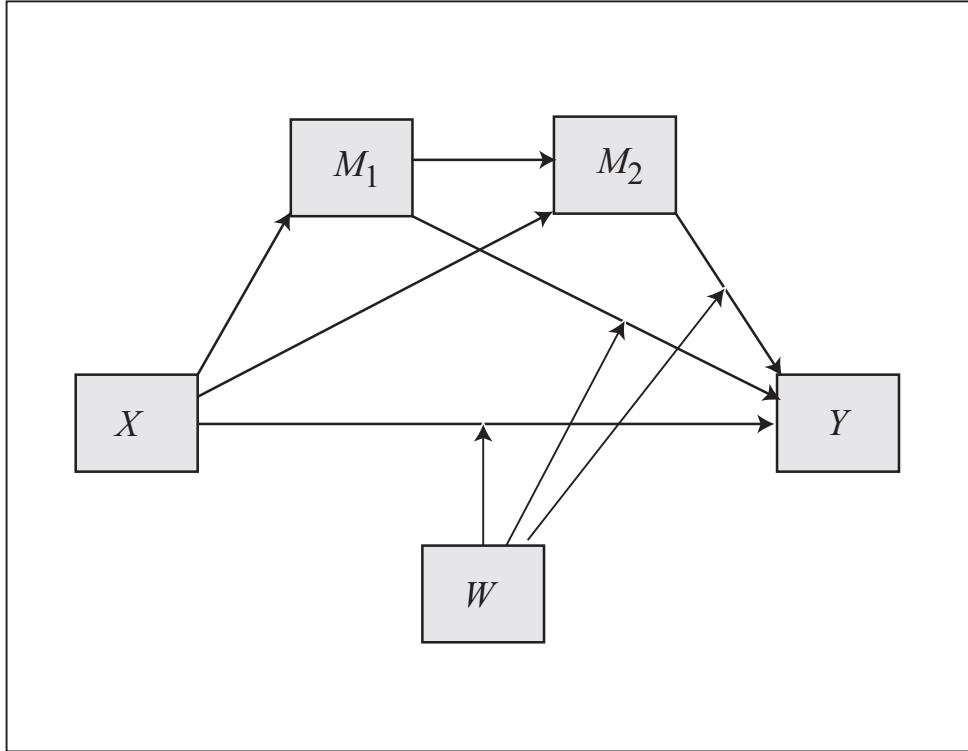
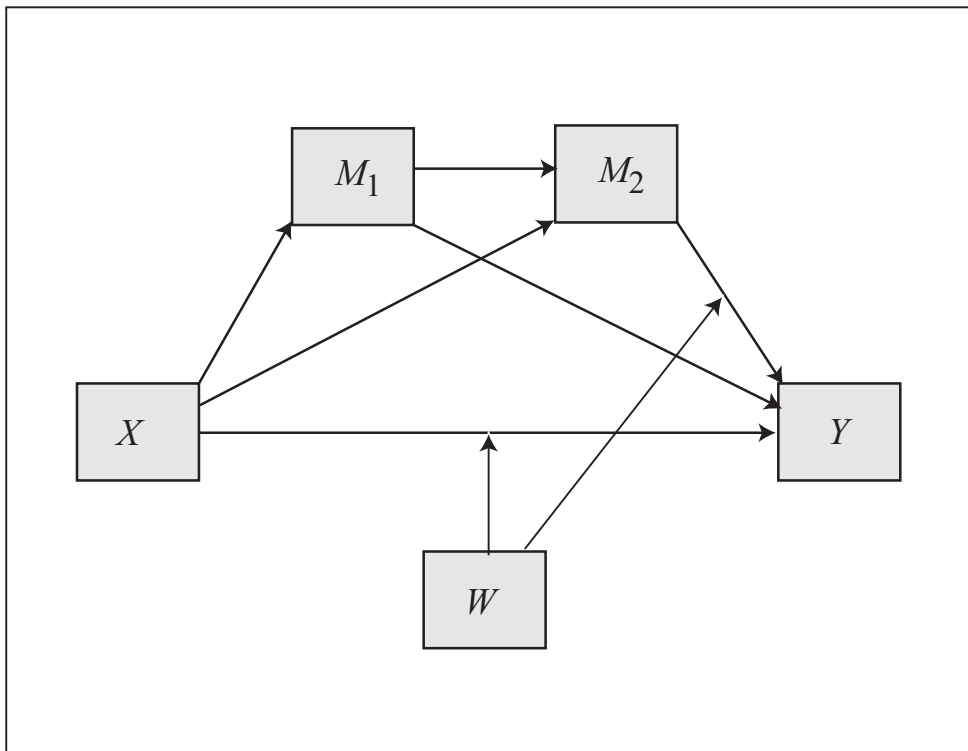
Model 89**Model 90**

Model 91

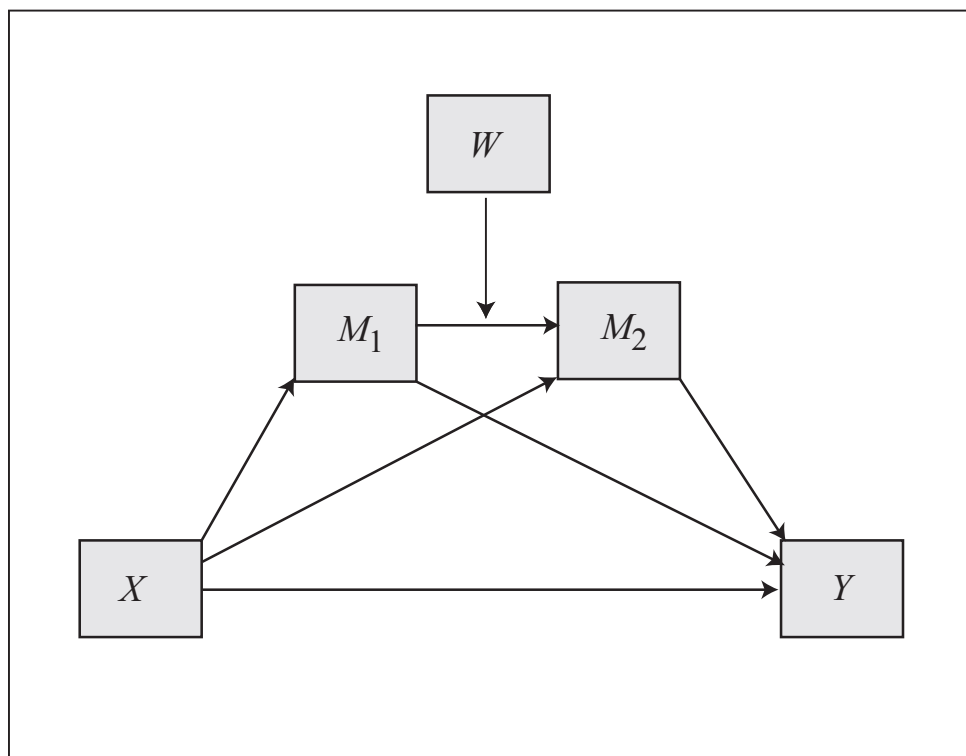

Model 92

